



# DEEP SEA ELECTRONICS

## DSE890 MKII 4G Gateway Operator Manual

Document Number: 057-304

Author: Ashley Senior



**Deep Sea Electronics Ltd.**

Highfield House  
Hunmanby  
North Yorkshire  
YO14 0PH  
England

**Sales Tel:** +44 (0) 1723 890099

**E-mail:** [sales@deepseaelectronics.com](mailto:sales@deepseaelectronics.com)

**Website:** [www.deepseaelectronics.com](http://www.deepseaelectronics.com)

**DSE890 MKII 4G Gateway Operator Manual**

© Deep Sea Electronics Ltd.

All rights reserved. No part of this publication may be reproduced in any material form (including photocopying or storing in any medium by electronic means or other) without the written permission of the copyright holder except in accordance with the provisions of the Copyright, Designs and Patents Act 1988.

Applications for the copyright holder's written permission to reproduce any part of this publication must be addressed to Deep Sea Electronics Ltd. at the address above.

The DSE logo and the names DSEGenSet®, DSEAts®, DSEControl® and DSEPower® are UK registered trademarks of Deep Sea Electronics Ltd.

Any reference to trademarked product names used within this publication is owned by their respective companies.

Deep Sea Electronics Ltd. reserves the right to change the contents of this document without prior notice.

**Amendments Since Last Publication**

<b>Issue No.</b>	<b>Comments</b>
1	Initial Release
2	Updated to match v2 firmware
3	Updated to cover the v3 firmware improvements
4	Updated to cover v4.2 firmware improvements

Typeface: The typeface used in this document is *Arial*. Care must be taken not to mistake the upper-case letter I with the numeral 1. The numeral 1 has a top serif to avoid this confusion.

## TABLE OF CONTENTS

Section	Page
<b>1 INTRODUCTION.....</b>	<b>6</b>
1.1 CLARIFICATION OF NOTATION.....	7
1.2 GLOSSARY OF TERMS.....	7
1.3 BIBLIOGRAPHY .....	9
1.3.1 INSTALLATION INSTRUCTIONS.....	9
1.3.2 MANUALS .....	9
1.3.3 TRAINING GUIDES .....	10
<b>2 SPECIFICATION.....</b>	<b>11</b>
2.1 SYSTEM OVERVIEW.....	11
2.1.1 DSEWEBNET SYSTEM OVERVIEW .....	11
2.1.2 MQTT SYSTEM OVERVIEW.....	12
2.2 DIMENSIONS AND MOUNTING .....	13
2.3 TYPICAL WIRING DIAGRAM.....	14
2.4 USER CONNECTIONS .....	15
2.4.1 TERMINAL SPECIFICATION.....	16
2.4.2 CONNECTOR A – DC SUPPLY, DIGITAL INPUTS AND DIGITAL OUTPUTS.....	16
2.4.2.1 POWER SUPPLY REQUIREMENTS .....	16
2.4.2.2 DIGITAL INPUTS .....	17
2.4.2.3 DIGITAL OUTPUTS .....	17
2.4.3 CONNECTOR B – RS485 AND CAN.....	17
2.4.3.1 CAN CONNECTION .....	18
2.4.3.2 RS485 CONNECTION .....	19
2.4.4 USB CONNECTION.....	20
2.4.5 ETHERNET CONNECTION.....	21
2.4.6 GSM CONNECTIONS.....	23
2.4.6.1 SUPPORTED FREQUENCY BANDS.....	23
2.4.7 GPS CONNECTION.....	25
2.4.8 STANDARD SIM CARD HOLDER .....	26
2.4.8.1 HOW TO INSERT THE GSM SIM CARD .....	26
2.4.9 MICROSD CARD HOLDER .....	26
2.5 DSEGATEWAY® CONNECTION TO SERVER .....	27
2.5.1 VIA ETHERNET .....	27
2.5.2 VIA GSM.....	27
2.5.3 DSEWEBNET®.....	28
2.5.3.1 SERVER CONNECTION INFORMATION.....	28
2.5.3.2 FIREWALL SETTINGS .....	29
2.5.4 MQTT .....	30
2.5.4.1 SERVER CONNECTION INFORMATION.....	30
2.5.4.2 FIREWALL SETTINGS .....	30
2.6 BROWSER COMPATIBILITY .....	31
2.6.1 GOOGLE CHROME .....	31
2.6.2 MICROSOFT EDGE.....	31
2.6.3 INTERNET EXPLORER.....	31
2.6.4 SAFARI.....	31
2.6.5 SMARTPHONE BROWSERS.....	31
2.7 DSE MODULE COMPATIBILITY.....	32
<b>3 QUICK SET UP GUIDE FOR DSEWEBNET® .....</b>	<b>33</b>
3.1 PREREQUISITES.....	33
3.2 STEP ONE: CONNECT AND CONFIGURE THE DSEGATEWAY®.....	34
3.3 STEP TWO: CONNECT THE MODULE.....	35
3.4 STEP THREE: CONFIGURE THE INTERNET CONNECTION.....	35
3.5 STEP FOUR: CHECK CONNECTION.....	36
3.6 STEP FIVE: ADD THE DSEGATEWAY® TO DSEWEBNET® .....	37
<b>4 CONTROLS AND INDICATIONS .....</b>	<b>38</b>

4.1	RESET PUSHBUTTON.....	38
4.2	LED INDICATIONS .....	39
<b>5</b>	<b>USER PAGES.....</b>	<b>40</b>
5.1	CONNECTING TO THE DSEGATEWAY® MANAGEMENT PAGES.....	40
5.2	STATUS .....	41
5.2.1	INFO .....	41
5.2.2	NETWORK.....	42
5.2.3	WEBNET .....	44
5.2.4	MQTT .....	46
5.2.5	GSM .....	47
5.2.6	LOCATION .....	47
5.2.7	I/O.....	48
5.2.8	COMMS.....	48
5.3	CONFIGURATION .....	49
5.3.1	INFO .....	50
5.3.2	NETWORK.....	51
5.3.3	WEBNET .....	52
5.3.4	MQTT .....	53
5.3.5	GSM .....	56
5.3.6	LOCATION .....	58
5.3.7	IO.....	59
5.3.8	TIME .....	60
5.3.9	FILE SYSTEM .....	61
5.4	MODULES CONNECTION (ADDING AND REMOVING MODULES).....	63
5.4.1	MODULES.....	63
5.4.2	DSEWEBNET.....	67
5.4.3	MQTT .....	69
5.4.4	MODBUS.....	71
5.4.4.1	EXAMPLE OF MODBUS PASSTHROUGH VIA ETHERNET OR GSM .....	73
<b>6</b>	<b>MQTT.....</b>	<b>74</b>
6.1	TOPICS .....	74
6.2	TOPIC FILE .....	75
6.2.1	TOPIC.....	76
6.2.2	TOPIC MASK .....	77
6.2.3	TYPE .....	77
6.2.4	PROPERTIES .....	77
6.2.5	PERIOD.....	77
6.2.6	QOS.....	78
6.2.7	EXPIRY .....	78
6.2.8	FLAGS.....	79
6.2.9	FUNCTION.....	80
6.2.9.1	0: AUTO SUBSCRIBE FUNCTION.....	80
6.2.9.2	1: GENCOMM (MODBUS) REGISTERS PUBLISH AND SUBSCRIBE.....	81
6.2.9.3	2: GENERIC MODBUS R/W REQUEST (CONFIG SUITE) .....	82
6.2.9.4	3: GENSET CONTROL KEY.....	82
6.2.9.5	4: ALARM .....	83
6.2.9.6	5: EVENT .....	84
6.2.9.7	6: J1939.....	85
6.2.9.8	7: X.509 CERTIFICATE UPDATE .....	86
6.2.9.9	8: X.509 CERTIFICATE STATUS.....	87
6.2.9.10	9: TOPIC LIST UPDATE .....	88
6.2.9.11	10: GPS LOCATION .....	88
6.2.9.12	11: FIXED DATA .....	89
6.2.9.13	12: CONNECTION DETAILS UPDATE .....	90
6.2.9.14	13: J1939 DTC .....	90
6.2.10	FIELD 1 TO FIELD 9.....	91
6.3	DSEGATEWAY MODBUS REGISTERS.....	92
<b>7</b>	<b>FIRMWARE UPGRADE.....</b>	<b>93</b>

<b>7.1</b>	<b>UPDATING THE FIRMWARE</b> .....	<b>93</b>
7.1.1	HOW TO FORMAT A USB FLASH MEMORY STICK TO FAT .....	95
<b>8</b>	<b>FAULT DIAGNOSIS</b> .....	<b>96</b>
8.1	FREQUENTLY ASKED QUESTIONS .....	96
8.2	DSEWEBNET CONNECTION TROUBLESHOOTING.....	98
<b>9</b>	<b>MAINTENANCE, SPARES, REPAIR, AND SERVICING</b> .....	<b>100</b>
9.1	PURCHASING ADDITIONAL PLUGS FROM DSE.....	100
9.2	PURCHASING AN ADDITIONAL USB CABLE FROM DSE.....	100
9.3	PURCHASING AN ADDITIONAL ANTENNA DSE.....	100
<b>10</b>	<b>WARRANTY</b> .....	<b>100</b>
<b>11</b>	<b>DISPOSAL</b> .....	<b>100</b>
11.1	WEEE (WASTE ELECTRICAL AND ELECTRONIC EQUIPMENT) .....	100

## 1 INTRODUCTION

This document details the installation requirements of the DSE890 MKII 4G DSEGateway®.

The manual forms part of the product and must be kept for the entire life of the product. If the product is passed or supplied to another party, ensure that this document is passed to them for reference purposes.

This is not a *controlled document*. Any future updates of this document are included on the DSE website at [www.deepseaelectronics.com](http://www.deepseaelectronics.com).



The DSEGateway® is setup using a PC and a network cable as detailed later in this document. The DSEGateway® is used in conjunction with supported DSE Modules to provide internet-based monitoring and control via DSEWebNet® and/or a 3<sup>rd</sup> party MQTT Broker. The DSEWebNet® is accessed using a PC and/or SmartPhone (App or Web browser) with an internet connection. This allows viewing of live and historic data as well as control. The MQTT Broker is accessed using 3<sup>rd</sup> party software and devices which are outside the scope of DSE.

Communication between the DSEGateway® and DSEWebNet® server and/or MQTT Broker is via GSM or Ethernet based internet connectivity. Additionally, the DSEGateway® includes GPS (satellite location) functionality. This is most suited for remote and/or mobile locations.

For details on accessing the DSEGateway® using the DSEWebNet® system, refer to DSE publication *057-168 DSEWebNet® Software Manual* available from the DSE website at; [www.deepseaelectronics.com](http://www.deepseaelectronics.com).

## 1.1 CLARIFICATION OF NOTATION

Clarification of notation used within this publication.

 <b>NOTE:</b>	Highlights an essential element of a procedure to ensure correctness.
 <b>CAUTION!</b>	Indicates a procedure or practice, which, if not strictly observed, could result in damage or destruction of equipment.
 <b>WARNING!</b>	Indicates a procedure or practice, which could result in injury to personnel or loss of life if not followed correctly.

## 1.2 GLOSSARY OF TERMS

Term	Description
BMS	Building Management System. A digital/computer based control system for a building's infrastructure.
CAN	Controller Area Network. Vehicle standard to allow digital devices to communicate to one another.
DM1	Diagnostic Message 1 A DTC that is currently active on the third party CAN device.
DM2	Diagnostic Message 2 A DTC that was previously active on the third-party CAN device and has been stored in the its internal memory.
DTC	Diagnostic Trouble Code The name for the entire fault code sent by an engine ECU.
FMI	Failure Mode Indicator A part of DTC that indicates the type of failure, e.g. high, low, open circuit etc.
GPS	Global Positioning System. A device that is capable of receiving information from GPS satellites and then to calculate the device's geographical position.
GPRS	General Packet Radio Services. Wireless communication service that provides continuous connection to the Internet for mobile phones and computer users.
GSM	Global System for Mobile Communications. A standard which describes the protocols for second-generation (2G) digital cellular networks used by mobile devices such as mobile phones and tablets.
J1939	SAE J1939 Society of Automotive Engineers standard SAE J1939 is the vehicle bus recommended practice used for communication and diagnostics among vehicle components using CAN.
LTE	Long-Term Evolution. A standard for wireless broadband communication for mobile devices and data terminals, based on the GSM with increases in capacity and speed.
Modbus	Modbus A data communications protocol used by programmable logic controllers (PLCs) to talk to one another over RS485 or ethernet.
Modbus Client	Modbus Initiates communication and makes requests from a Modbus Server device.
Modbus Server	Modbus Processes requests and returns appropriate response to Modbus client device.

Descriptions continued overleaf...

Term	Description
MQTT	MQ Telemetry Transport MQTT is an OASIS standard messaging protocol for the Internet of Things (IoT). It is designed as an extremely lightweight publish/subscribe messaging transport that is ideal for connecting remote devices with a small code footprint and minimal network bandwidth.
MQTT Broker	MQ Telemetry Transport Broker A service that is installed on a server or cloud provider that routes Published MQTT Topics to the MQTT Clients which have subscribed to them.
MQTT Client	MQ Telemetry Transport Client A device that subscribes to and/or publishes MQTT Topics to an MQTT Broker.
MQTT Publisher	MQ Telemetry Transport Publisher A MQTT Client that sends (publishes) MQTT Topics to the MQTT Broker. An MQTT Client can be both a MQTT Publisher and a MQTT Subscriber.
MQTT Subscriber	MQ Telemetry Transport Subscriber An MQTT Client that receives (subscribes) MQTT Topics from an MQTT Broker that have been published to it by another MQTT Client. An MQTT Client can be both a MQTT Publisher and a MQTT Subscriber.
MQTT Topic	MQ Telemetry Transport Topic A data object of any format that can be published to an MQTT Broker from an MQTT Client and/or published to a subscribed MQTT Client from an MQTT Broker. Each topic has a unique identifier.
OC	Occurrence Count A part of DTC that indicates the number of times that failure has occurred.
PGN	Parameter Group Number A CAN address for a set of parameters that relate to the same topic and share the same transmission rate.
SIM	Subscriber Identity Module. The small card supplied by the GSM/CDMA provider that is inserted into the cell phone, GSM modem or DSEGateway® device to give GSM connection.
SMS	Short Message Service. The text messaging service of mobile/cell phones.
SPN	Suspect Parameter Number A part of DTC that indicates what the failure is, e.g. oil pressure, coolant temperature, turbo pressure etc.
TLS	Transport Layer Security A cryptographic protocol designed to provide communications security over a computer network.
WCDMA	Wideband Code Division Multiple Access. A spread-spectrum modulation technique which uses channels whose bandwidth is much greater than that of the data to be transferred. Instead of each connection being granted a dedicated frequency band just wide enough to accommodate its envisaged maximum data rate, WCDMA channels share a much larger band.
QoS	Quality of Service An agreement between the sender of an MQTT message and the receiver of an MQTT message that defines the guarantee of delivery for a specific message. There are 3 QoS levels in MQTT: <ul style="list-style-type: none"> <li>• At most once (0)</li> <li>• At least once (1)</li> <li>• Exactly once (2)</li> </ul>

## 1.3 BIBLIOGRAPHY

This document refers to and is referred to by the following DSE publications which is obtained from the DSE website [www.deepseaelectronics.com](http://www.deepseaelectronics.com)

### 1.3.1 INSTALLATION INSTRUCTIONS

Installation instructions are supplied with the product in the box and are intended as a 'quick start' guide only.

DSE Part	Description
053-247	DSE890 MKII 4G Gateway Installation Instructions

### 1.3.2 MANUALS

Product manuals are obtained from the DSE website: [www.deepseaelectronics.com](http://www.deepseaelectronics.com) or by contacting DSE technical support: [support@deepseaelectronics.com](mailto:support@deepseaelectronics.com).

DSE Part	Description
057-165	DSE890 & DSE891 Operators Manual
057-235	DSEWebNet Smart Device Software Manual
057-156	DSE334 Configuration Suite PC Software Manual
057-237	DSE335 Configuration Suite PC Software Manual
057-267	DSEE100 Configuration Suite PC Software Manual
057-251	DSEE400 Configuration Suite PC Software Manual
057-203	DSEE800 Configuration Suite PC Software Manual
057-187	DSEL400 & DSEL401 Configuration Suite PC Software Manual
057-222	DSEL401 MKII Configuration Suite PC Software Manual
057-186	DSEP100 Configuration Suite PC Software Manual
057-178	DSE4310 & DSE4320 Configuration Suite PC Software Manual
057-093	DSE4410 & DSE4420 Configuration Suite PC Software Manual
057-172	DSE4510 & DSE4520 Configuration Suite PC Software Manual
057-258	DSE4510 MKII & DSE4520 MKII Configuration Suite PC Software Manual
057-201	DSE4610 & DSE4620 Configuration Suite PC Software Manual
057-114	DSE6010 & DSE6020 Configuration Suite PC Software Manual
057-223	DSE6010 MKII & DSE6020 MKII Configuration Suite PC Software Manual
057-096	DSE6110 & DSE6120 Configuration Suite PC Software Manual
057-224	DSE6110 MKII & DSE6120 MKII Configuration Suite PC Software Manual
057-290	DSE6110 MKIII & DSE6120 MKIII Configuration Suite PC Software Manual
057-117	DSE7110 & DSE7120 Configuration Suite PC Software Manual
057-185	DSE7110 MKII & DSE7120 MKII Configuration Suite PC Software Manual
057-077	DSE72xx & DSE73xx Configuration Suite PC Software Manual
057-243	DSE7310 MKII & DSE7320 MKII Configuration Suite PC Software Manual
057-160	DSE7410 & DSE7420 Configuration Suite PC Software Manual
057-262	DSE7410 MKII & DSE7420 MKII Configuration Suite PC Software Manual
057-119	DSE8610, DSE8620 & DSE8660 Configuration Suite PC Software Manual
057-238	DSE8610 MKII Configuration Suite PC Software Manual
057-257	DSE8660 MKII Configuration Suite PC Software Manual
057-127	DSE8710 & DSE8760 Configuration Suite PC Software Manual
057-164	DSE8810 Configuration Suite PC Software Manual
057-174	DSE8860 Configuration Suite PC Software Manual
057-303	DSE8920 Configuration Suite PC Software Manual
057-322	DSEG8600 Configuration Suite PC Software Manual
057-324	DSEG8660 Configuration Suite PC Software Manual
057-326	DSEG8680 Configuration Suite PC Software Manual

### 1.3.3 TRAINING GUIDES

Training guides are provided as 'hand-out' sheets on specific subjects during training sessions and contain specific information regarding to that subject.

<b>DSE Part</b>	<b>Description</b>
056-006	Introduction to Comm's
056-080	Modbus
056-121	DSE890 MKII 4G Gateway Quick Set-up Guide

## 2 SPECIFICATION

### 2.1 SYSTEM OVERVIEW

#### 2.1.1 DSEWEBNET SYSTEM OVERVIEW

The DSEGateway<sup>®</sup> connects to the DSEWebNet<sup>®</sup> Server using an internet connection provide by ethernet or GSM (2G, 3G or 4G mobile internet) connections. The DSEGateway<sup>®</sup> connects to the DSE module via USB, RS485 and ethernet.

The DSEWebNet<sup>®</sup> is accessed at [www.dsewebnet.com](http://www.dsewebnet.com) using a PC with a supported internet browser or via the DSEWebNet<sup>®</sup> App on supported smart devices. This enables the user to perform remote control and live monitoring of the connected DSE modules. The user is also able to configure the DSEWebNet<sup>®</sup> to send SMS alerts from the DSEGateway's SIM card and Email Alerts/Reports from the DSEWebNet<sup>®</sup> Server.

Below is an overview depicting how this is achieved...

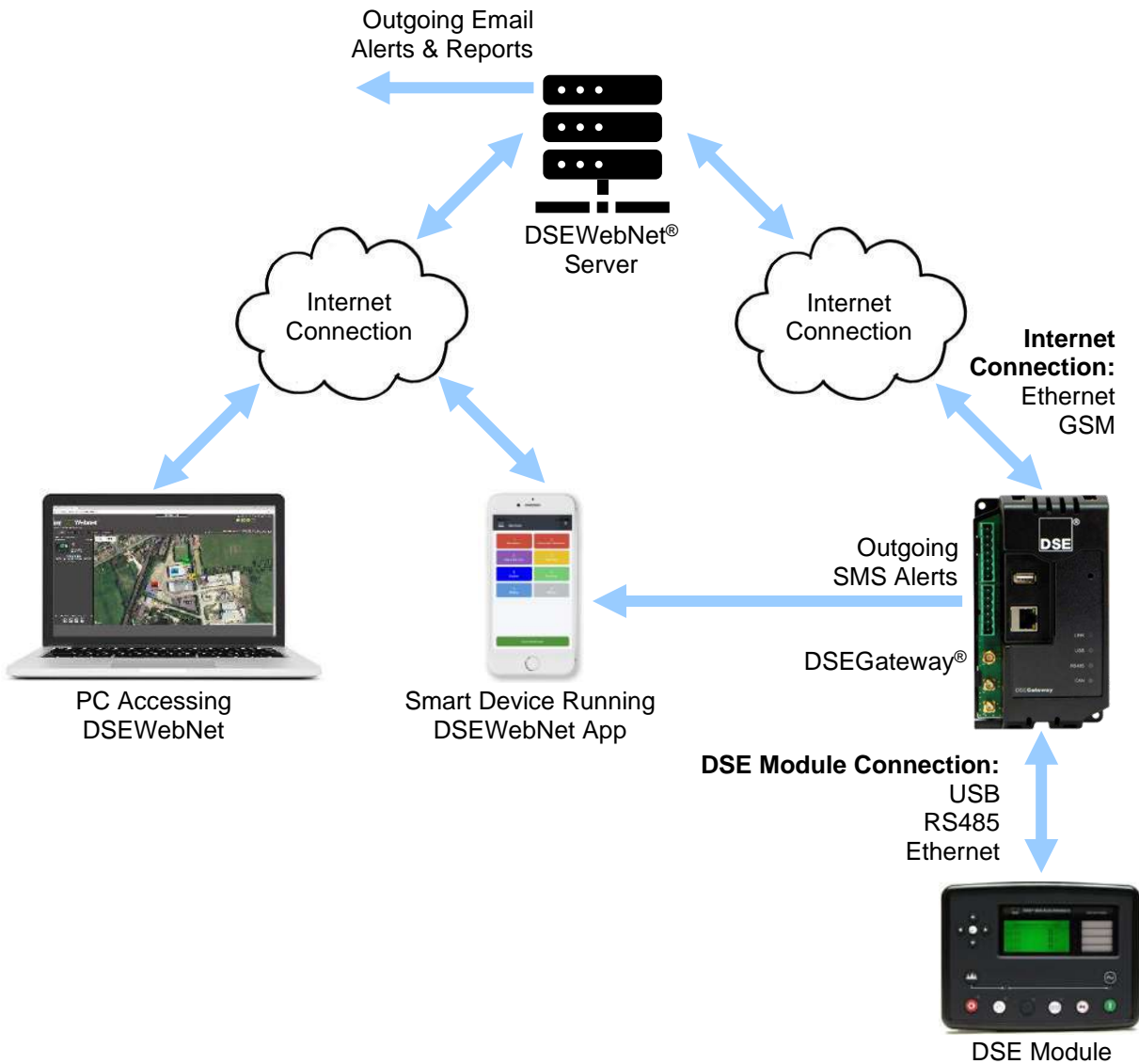

### 2.1.2 MQTT SYSTEM OVERVIEW

The DSEGateway<sup>®</sup> connects to the DSE module via USB, RS485 and ethernet, or a 3<sup>rd</sup> party CAN device using J1939. Using this connection, the DSEGateway<sup>®</sup> attains information/parameters from the connected devices and populates them into MQTT Topics.

The DSEGateway<sup>®</sup> is an MQTT Client that publishes the MQTT Topics to an MQTT Broker. The MQTT Broker is normally running on a third-party server or cloud service and thus the connection is established using an internet connection provided by the ethernet or GSM (2G, 3G or 4G mobile internet) connections.

The MQTT Broker publishes the MQTT Topics to any MQTT Client that is subscribed to that Topic. A 3<sup>rd</sup> party MQTT Client may also publish a MQTT Topic containing control commands to the MQTT Broker. As long as the DSEGateway<sup>®</sup> is subscribed to that MQTT Topic containing control commands, the MQTT Broker publishes them to it once received. Essentially the MQTT Broker is acting as a distributor of information between the MQTT Clients.

Below is an overview depicting how this is achieved...

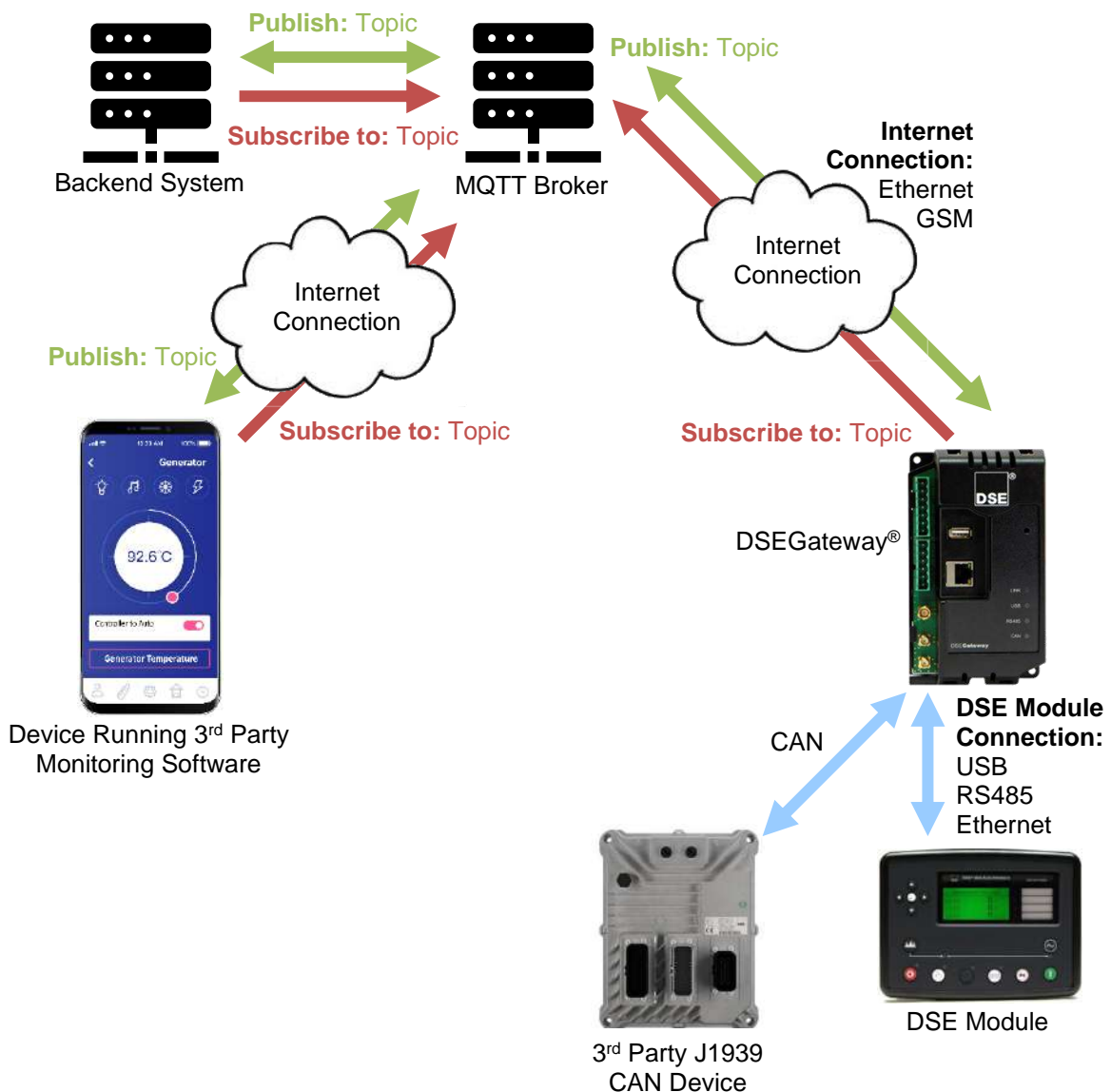

## 2.2 DIMENSIONS AND MOUNTING

The DSEGateway® is designed to be mounted within a control panel, either on the panel DIN rail utilising the integral mounts, or chassis mounted utilising the mounting holes.

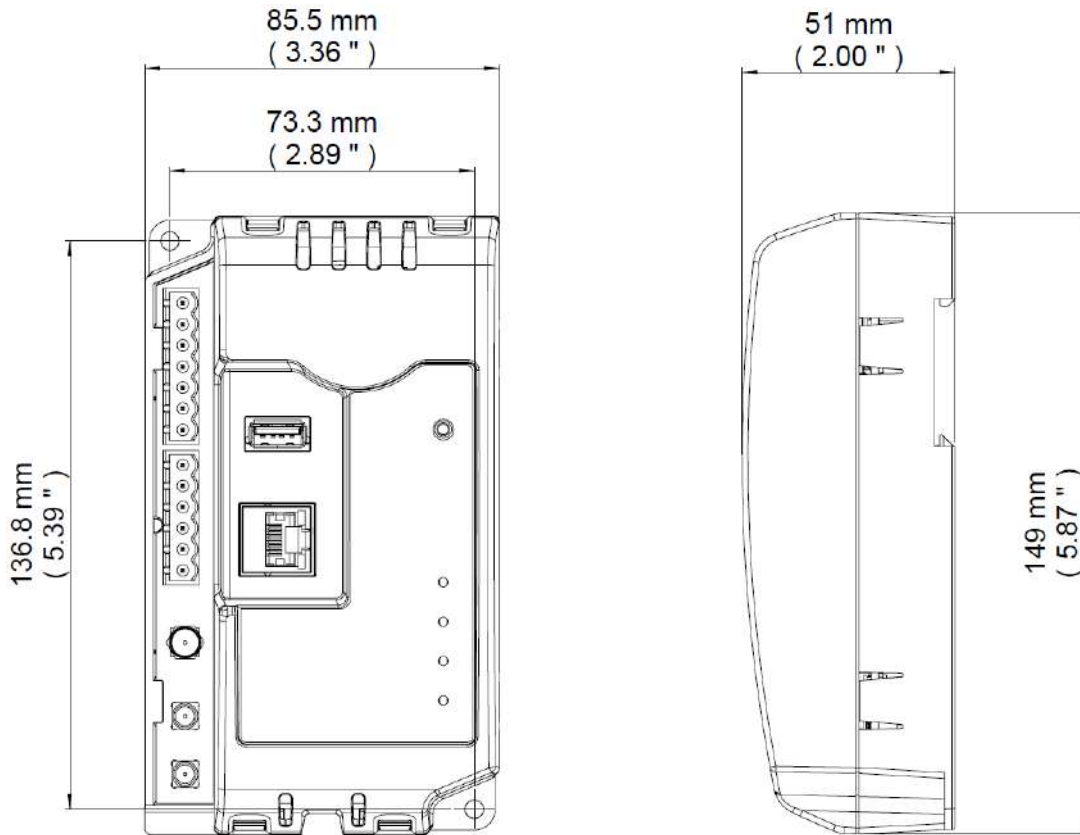

Description	Specification
Overall Size	85 mm X 149 mm X 51 mm (3.35 " X 5.85 " X 2.01 ")
Mounting Type	DIN rail or chassis mounting, indoor use only.
DIN Rail Width	EN 50022: 35 mm (1.4 ")
Mounting Holes	M4 (0.25 ")
Mounting Hole Centres	73 mm X 137 mm (2.89 " X 5.39 ")
Operating Temperature	-30 °C to 60 °C (-22 °F to 140 °F)
Operating Temperature for UL Certification	-30 °C to 50 °C (-22 °F to 122 °F)
Storage Temperature	-40 °C to 80 °C (-40 °F to 176 °F)
Weight	0.25 kg (0.55 lbs)

### 2.3 TYPICAL WIRING DIAGRAM

**NOTE:** For UL Approvals, a UL listed limited power supply suited for 8 V<sub>DC</sub> to 36 V<sub>DC</sub> must be used.

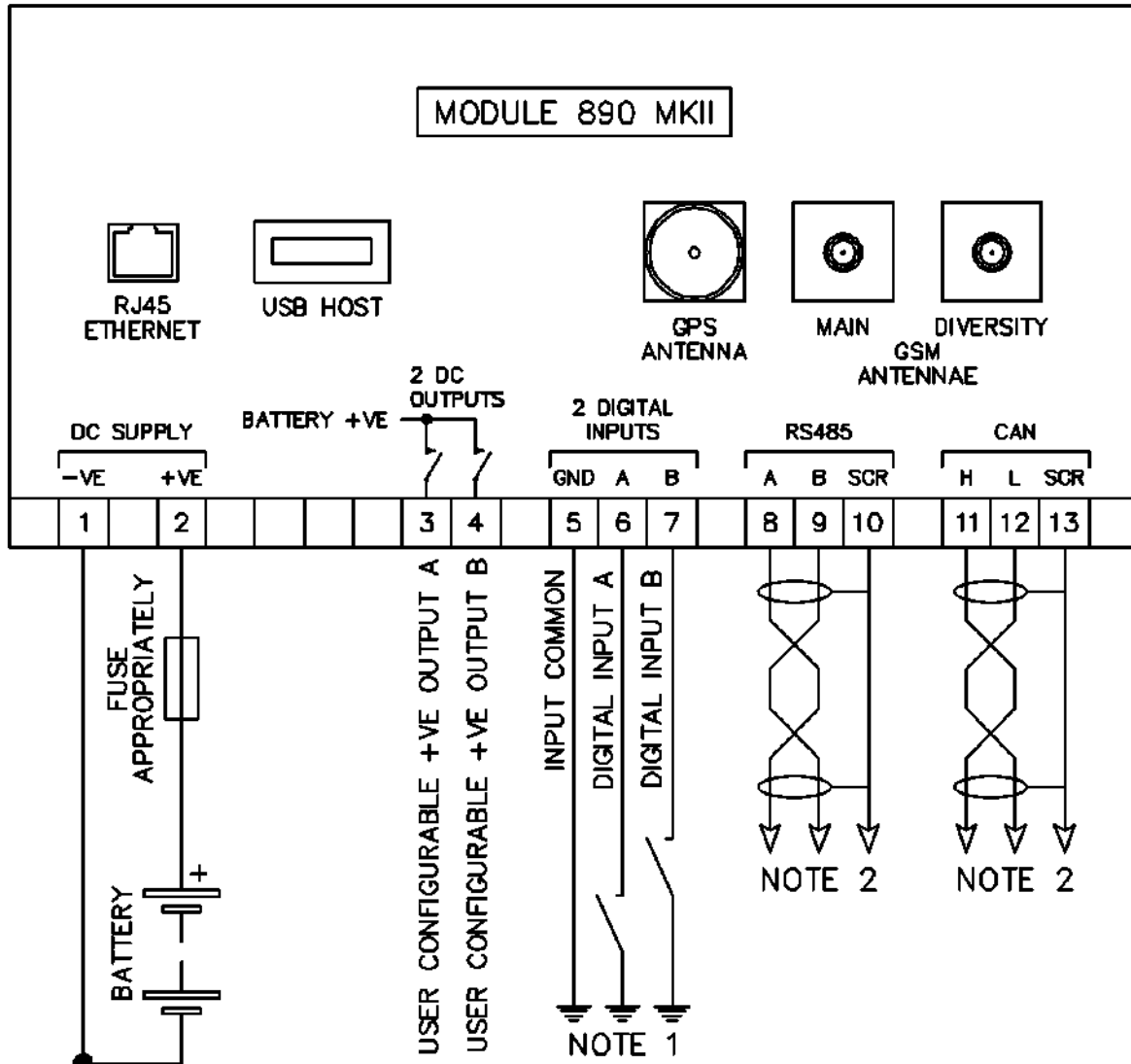

BATTERY NEGATIVE MUST BE GROUNDED

NOTE 1. THESE GROUND CONNECTIONS MUST BE CONNECTED TO THE SAME GROUND AS BATTERY NEGATIVE.

NOTE 2. IF THE MODULE IS FIRST OR LAST UNIT ON THE LINK, IT MUST BE FITTED WITH A 120 OHM TERMINATION RESISTOR ACROSS THE A AND B OR H AND L TERMINALS.

## 2.4 USER CONNECTIONS

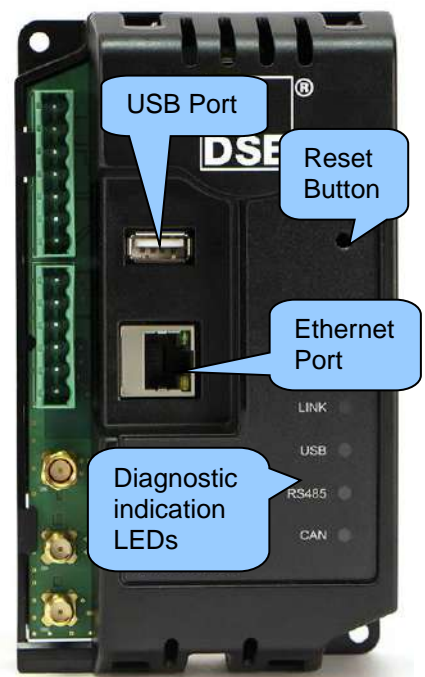
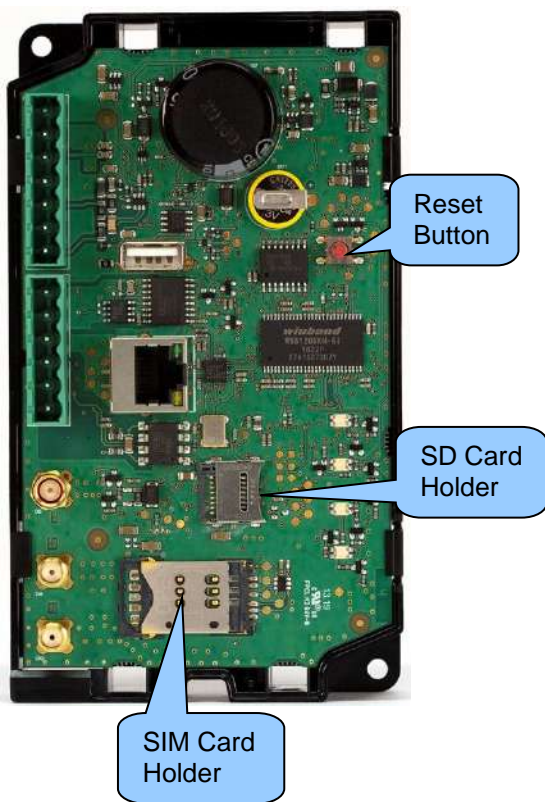
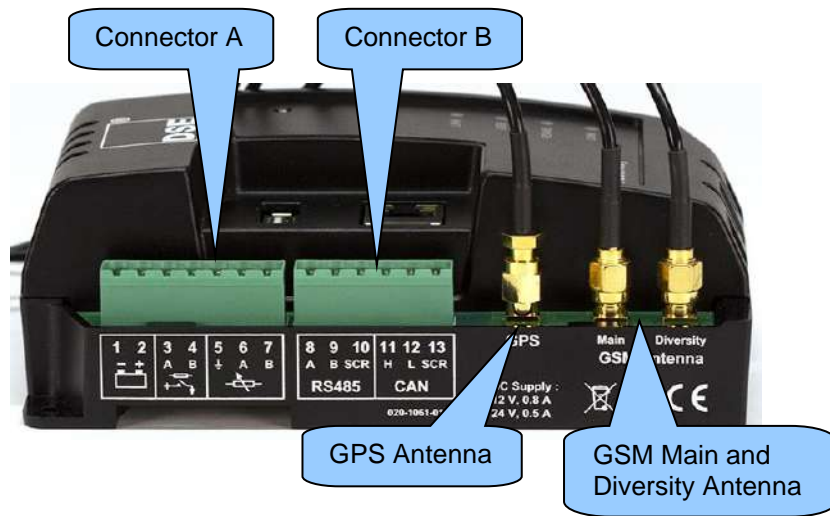

To aid user connection, icons are used on the side of the module to help identify terminal functions. An example of this is shown below...



### 2.4.1 TERMINAL SPECIFICATION

Description	Specification	
Connection Type	Two part connector. Male part fitted to module Female part supplied in module packing case - Screw terminal, rising clamp, no internal spring.	 <p>Example showing cable entry and screw terminals of a 10 way connector</p>
Minimum Cable Size	0.5 mm <sup>2</sup> (AWG 20)	
Maximum Cable Size	2.5 mm <sup>2</sup> (AWG 13)	
Tightening Torque	0.5 Nm (4.5 lb-in)	
Wire Strip Length	7 mm (9/32 ")	

### 2.4.2 CONNECTOR A – DC SUPPLY, DIGITAL INPUTS AND DIGITAL OUTPUTS

	Pin No	Description	Cable Size	Notes
	1	DC Plant Supply Input (Negative)	0.5 mm <sup>2</sup> AWG 20	Connect to ground where applicable.
	2	DC Plant Supply Input (Positive)	0.5 mm <sup>2</sup> AWG 20	Supplies the module and DC Outputs A & B
	3	Digital Output A	0.5 mm <sup>2</sup> AWG 20	Plant Supply Positive from terminal 2. 2 A DC rated.
	4	Digital Output B	0.5 mm <sup>2</sup> AWG 20	Plant Supply Positive from terminal 2. 2 A DC rated.
	5	Digital Input Earth	0.5 mm <sup>2</sup> AWG 20	Ground Return Feed For Digital Input's.
	6	Digital Input A	0.5 mm <sup>2</sup> AWG 20	Switch To Negative.
	7	Digital Input B	0.5 mm <sup>2</sup> AWG 20	Switch To Negative.

#### 2.4.2.1 POWER SUPPLY REQUIREMENTS

**NOTE:** For UL Approvals, a UL listed limited power supply suited for 8 V<sub>DC</sub> to 36 V<sub>DC</sub> must be used.

Range	Specification
Minimum Supply Voltage	8 V continuous.
Cranking Dropouts	Able to survive 0 V for 100 ms providing the supply was at least 8 V before the dropout and recovers to 8 V afterwards.
Maximum Supply Voltage	36 V continuous.
Power Up Current	3 A transient inrush at initial power up.
Maximum Standby Current	207 mA at 12 V 113 mA at 24 V
Maximum Operating Current	755 mA at 12 V 376 mA at 24 V

### 2.4.2.2 DIGITAL INPUTS

Description	Specification
Number	2 Digital Inputs
Arrangement	Volt Free Contact between terminal and digital input ground
Low Level Threshold	2.1 V minimum
High Level Threshold	6.6 V maximum
Maximum Input Voltage	+50 V DC with respect to plant supply negative.
Minimum Input Voltage	-24 V DC with respect to plant supply negative
Contact Wetting Current	7 mA typical.
Open Circuit Voltage	12 V typical

### 2.4.2.3 DIGITAL OUTPUTS

Description	Specification
Type	Supplied from DC supply terminal 2. Manually operated in the <i>Site I/O</i> section of the DSEWebNet® System or via MQTT commands.
Rating	2 A resistive at plant supply.

### 2.4.3 CONNECTOR B – RS485 AND CAN

	Pin No	Description	Cable Size	Notes
<b>RS485</b>	8	RS485 Port A (+)	0.5 mm <sup>2</sup> AWG 20	Connect to RXD+ and TXD+ Use only 120 Ω CAN or RS485 approved cable
	9	RS485 Port B (-)	0.5 mm <sup>2</sup> AWG 20	Connect to RXD- and TXD- Use only 120 Ω CAN or RS485 approved cable
	10	RS485 Port Screen	Shield	Use only 120 Ω CAN or RS485 approved cable
<b>CAN</b>	11	CAN Port H	0.5 mm <sup>2</sup> AWG 20	Use only 120 Ω CAN or RS485 approved cable
	12	CAN Port L	0.5 mm <sup>2</sup> AWG 20	Use only 120 Ω CAN or RS485 approved cable
	13	CAN Port Screen	Shield	Use only 120 Ω CAN or RS485 approved cable

2.4.3.1 CAN CONNECTION

**NOTE:** All communication ports can be used at the same time.

**NOTE:** The CAN communication port is only supported on MQTT system integration, it is not supported for DSEWebNet system integration.

This socket provides support for connection to multiple 3<sup>rd</sup> party J1939 CANbus devices in a daisy chain network. Ensure termination resistors (120 Ω) are fitted as shown to the ends of the link as per the CAN standard.

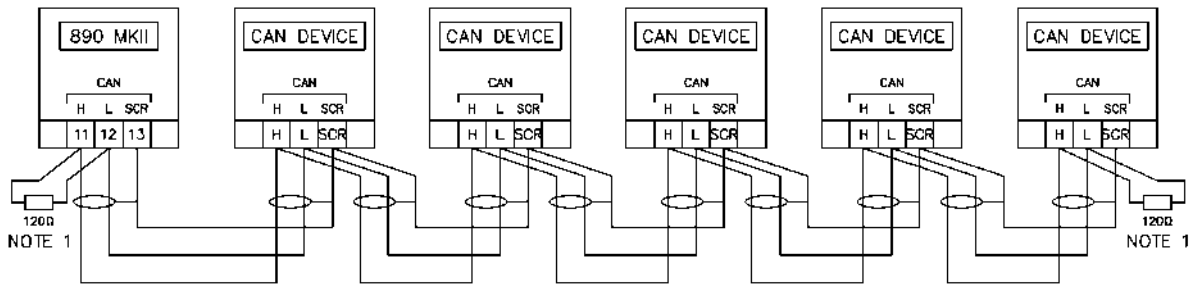

NOTE 1. A 120 OHM TERMINATION RESISTOR MUST BE FITTED ACROSS THE H AND L TERMINALS AT THE START AND END OF THE LINK

**CAN Specification**

Description	Specification
CAN Port	Isolated Data connection 2 wire + common Configurable bit rate of 125 kbit/s, 250 kbit/s and 500 kbit/s External termination required (120 Ω) Max distance 40 m (43.74 yards)

**Cable Specification**

**NOTE:** DSE recommend Belden 9841 (or equivalent) cable for CANbus communication. This is rated to a maximum cable length of 1.2 km. DSE Stock Belden 9841 cable, DSE Part Number: 016-030.

Description	Specification
Cable Type	Two core screened and shielded twisted pair.
Cable Characteristics	120 Ω impedance. Low capacitance.
Recommended Cable	Belden 9841. Belden 9271.
Maximum Cable Length	40 m (43.74 yards) when using Belden 9841 or direct equivalent. 20 m (21.87 yards) when using Belden 9271 or direct equivalent.
CAN Topology	“Daisy Chain” Bus with no stubs (spurs).
CAN Termination	120 Ω. Not fitted internally to module. Must be fitted externally to the ‘first’ and ‘last’ device on the CANbus link.

2.4.3.2 RS485 CONNECTION

**NOTE: All communication ports can be used at the same time.**

This socket provides support for connection to a maximum of 5 (five) DSE Modules in a daisy chain RS485 network. Ensure termination resistors (120 Ω) are fitted as shown to the ends of the link as per RS485 standard.

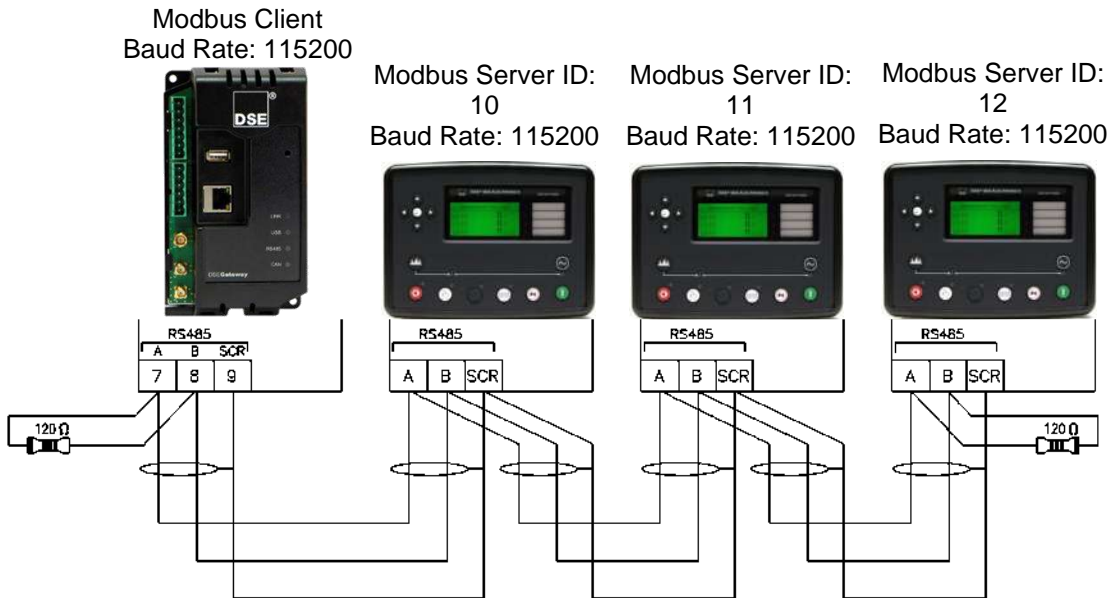

**RS485 Specification**

Description	Specification
RS485 Serial Port	Isolated Data connection 2 wire + common Half Duplex Data direction control for Transmit (by software protocol) Max Baud Rate 115200 baud subject to configuration External termination required (120 Ω) Max distance 1.2 km (¾ mile)

**Cable Specification**

**NOTE: DSE recommend Belden 9841 (or equivalent) cable for RS485 communication. This is rated to a maximum cable length of 1.2 km. DSE Stock Belden 9841 cable, DSE Part Number: 016-030.**

Description	Specification
Cable Type	Two core screened and shielded twisted pair.
Cable Characteristics	120 Ω impedance. Low capacitance.
Recommended Cable	Belden 9841. Belden 9271.
Maximum Cable Length	1.2 km (¾ mile) when using Belden 9841 or direct equivalent. 600 m (656 yards) when using Belden 9271 or direct equivalent.
RS485 Topology	“Daisy Chain” Bus with no stubs (spurs).
RS485 Termination	120 Ω. Not fitted internally to module. Must be fitted externally to the ‘first’ and ‘last’ device on the RS485 link.

### 2.4.4 USB CONNECTION

**NOTE:** DSE advise against the use of USB when used in close proximity to sources of electro- magnetic interference.

**NOTE:** All communication ports can be used at the same time.

**NOTE:** DSE stock a 1 m (3.3 feet) USB type A to type B cable with ferrite chokes, DSE Part Number: 016-180. Alternatively, they are purchased from any PC or IT store.

This USB type A socket provides a connection to one DSE Module. Firmware updates and configuration files are also installed via the USB port using a USB memory stick.

Use USB type A to USB type B cable with ferrite choke.

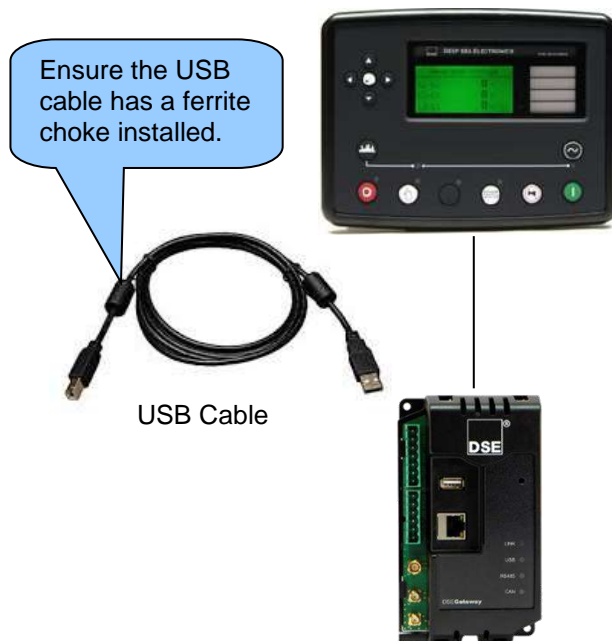

#### USB Specification

Description	Specification
USB Host Port	Type A USB 2.0

#### Cable Specification

Description	Specification
USB Cable	Type A to type B USB 2.0 (sometimes known as 'printer cable') screened cable with ferrite chokes. Max distance 5 m (16 feet) recording only

#### USB Memory Stick Requirements

Description	Specification
USB Memory Stick	Up to a maximum 16 GB size and formatted to FAT.

### 2.4.5 ETHERNET CONNECTION

**NOTE: All communication ports can be used at the same time.**

The Ethernet port is utilised to allow configuration of the Gateway, connection the internet and connection to the associated Modules.

An example utilising all three types on an isolated network connection is shown below...

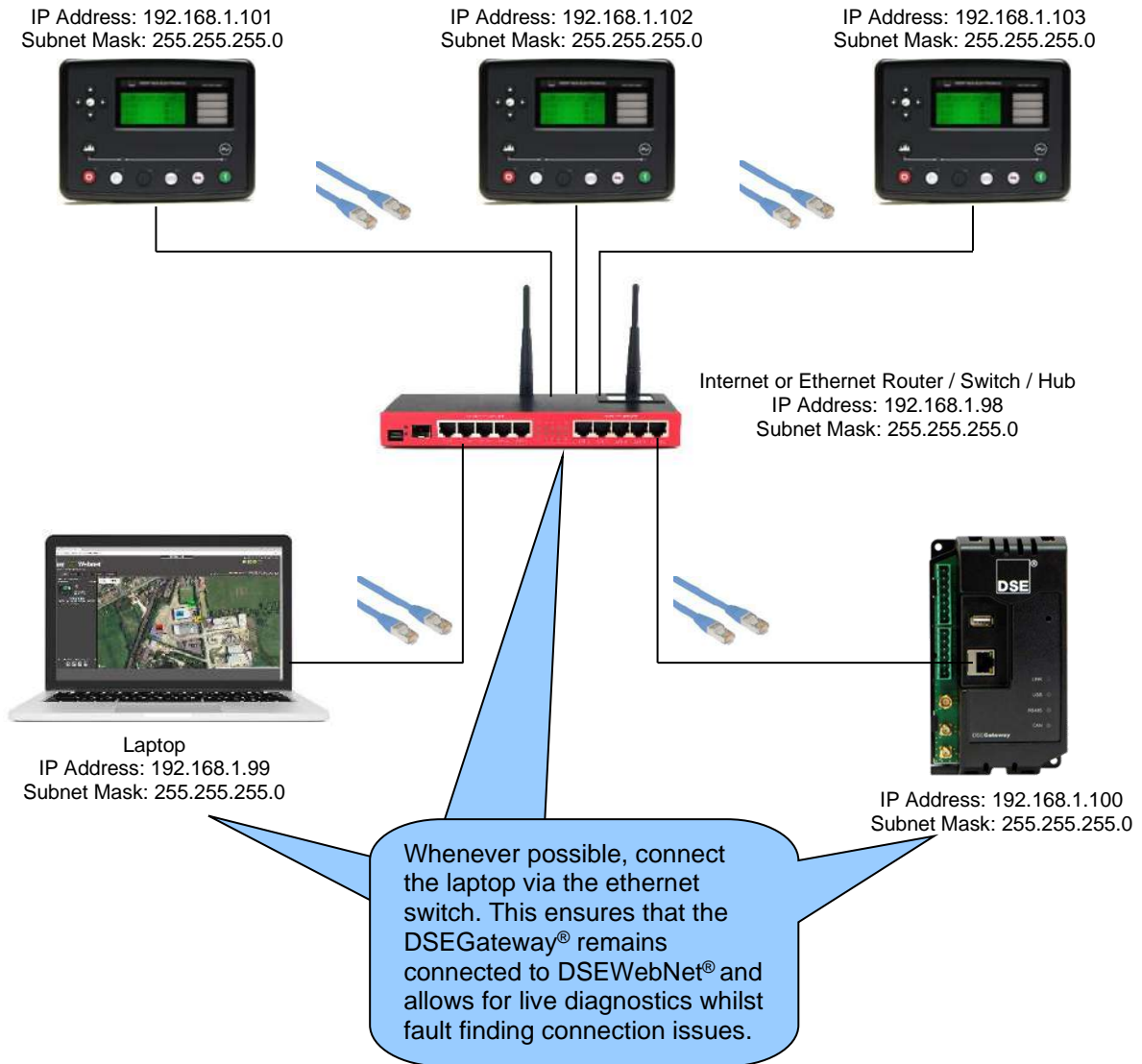

















**Ethernet Specification**

Description	Specification
Ethernet	Auto Detecting 10/100 Mbit port.

**Cable Specification**

**NOTE:** DSE Stock a 2m (2yds) Ethernet Cable – Part number 016-137. Alternatively they can be purchased from any PC or IT store.  
As the ethernet port is auto detecting, a ‘straight through’ or ‘crossover’ cable can be used.  
The diagram information below covers a ‘straight through’ type cable.

Ethernet connection utilises a standard Ethernet cable with RJ45 connectors

Pin	Connection 1 (T568A)	Connection 2 (T568A)
1	 white/green stripe	 white/green stripe
2	 green solid	 green solid
3	 white/orange stripe	 white/orange stripe
4	 blue solid	 blue solid
5	 white/blue stripe	 white/blue stripe
6	 orange solid	 orange solid
7	 white/brown stripe	 white/brown stripe
8	 brown solid	 brown solid

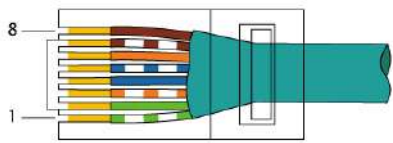

EIA/TIA-568A

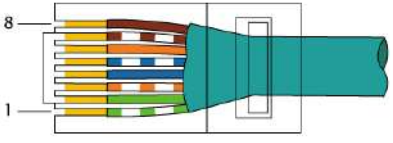



EIA/TIA-568A

## 2.4.6 GSM CONNECTIONS

**NOTE:** For details on how to configure the GSM setting, refer to section entitled *Quick Set Up Guide* elsewhere in this document.

**NOTE:** DSE stock a combined 4G LTE (Main & Diversity) and GPS Antenna with 3 m length of cable which is suitable for this purpose. Part number: 020-1053.

The DSEGateway® connects to the GSM through the use of an antenna. This allows for a more powerful signal strength. The connections are shown below.

	Connector	Required Antenna Cable Connector
GSM Main 	SMA FEMALE (Outside thread, female central receptacle)	SMA MALE (Inside thread, male central pin)
GSM Diversity 	SMA FEMALE (Outside thread, female central receptacle)	SMA MALE (Inside thread, male central pin)

### 2.4.6.1 SUPPORTED FREQUENCY BANDS

The WCDMA (3G) operating parameters and frequency bands that are supported by the DSEGateway® are listed below.

WCDMA Operating Mode	Specification
CS (Voice)	Yes
PS (Data)	Yes
HSDAP Cat	1 to 12
HSUPA Cat	1 to 12
Tx Diversity	Yes
Tx MIMO	Yes

WCDMA Band	Frequency	Hardware Version
Band 1 (BC1)	2100 MHz	
Band 2 (BC2)	1900 MHz	
Band 3 (BC3)	1800 MHz	002 only
Band 4 (BC4)	2100 MHz / 1700 MHz	
Band 5 (BC5)	850 MHz	
Band 6 (BC6)	850 MHz	002 only
Band 8 (BC8)	900 MHz	
Band 9 (BC9)	1700 MHz	001 only
Band 19 (BC19)	800 MHz	

*Specification*

The LTE (4G) operating parameters and frequency bands that are supported by the DSEGateway® are listed below.

<b>LTE Operating Mode</b>	<b>Specification</b>
3GPP Rel. No.	LTE Rel 9
3GPP UE Cat.	CAT1
Upload Modulation	SC-FDMA
Download Modulation	OFDMA
Tx Diversity	Yes
Tx MIMO	Yes

<b>LTE FDD Band</b>	<b>Frequency</b>	<b>Hardware Version</b>
Band 1 (BC1)	2100 MHz	
Band 2 (BC2)	1900 MHz	
Band 3 (BC3)	1800 MHz	
Band 4 (BC4)	1700 MHz	
Band 5 (BC5)	850 MHz	
Band 7 (BC7)	2600 MHz	
Band 8 (BC8)	900 MHz	
Band 12 (BC12)	700 MHz	
Band 13 (BC13)	700 MHz	002 only
Band 18 (BC18)	850 MHz	
Band 19 (BC19)	850 MHz	
Band 20 (BC20)	800 MHz	
Band 26 (BC26)	850 MHz	002 only
Band 28 (BC28)	700 MHz	
Band 38 (BC38)	2600 MHz	002 only
Band 40 (BC40)	2300 MHz	002 only
Band 41 (BC41)	2500 MHz	002 only
Band 66 (BC66)	2100 MHz	002 only

### 2.4.7 GPS CONNECTION

**▲ NOTE: DSE stock a combined 4G LTE (Main & Diversity) and GPS Antenna with 3 m length of cable which is suitable for this purpose. Part number: 020-1053.**

The DSEGateway® attains a GPS signal through the use of an antenna. This allows for a more powerful signal strength. The connections are shown below.

	Connector	Required Antenna Cable Connector
GPS 	SMA MALE (Inside thread, male central pin)	SMA FEMALE (Outside thread, female central receptacle)

## 2.4.8 STANDARD SIM CARD HOLDER

The DSEGateway® uses the *Standard* SIM card size (15 mm X 25 mm) to enable connection to a GSM (internet over GSM) network. 2G, 3G or 4G SIM cards are supported.

### 2.4.8.1 HOW TO INSERT THE GSM SIM CARD

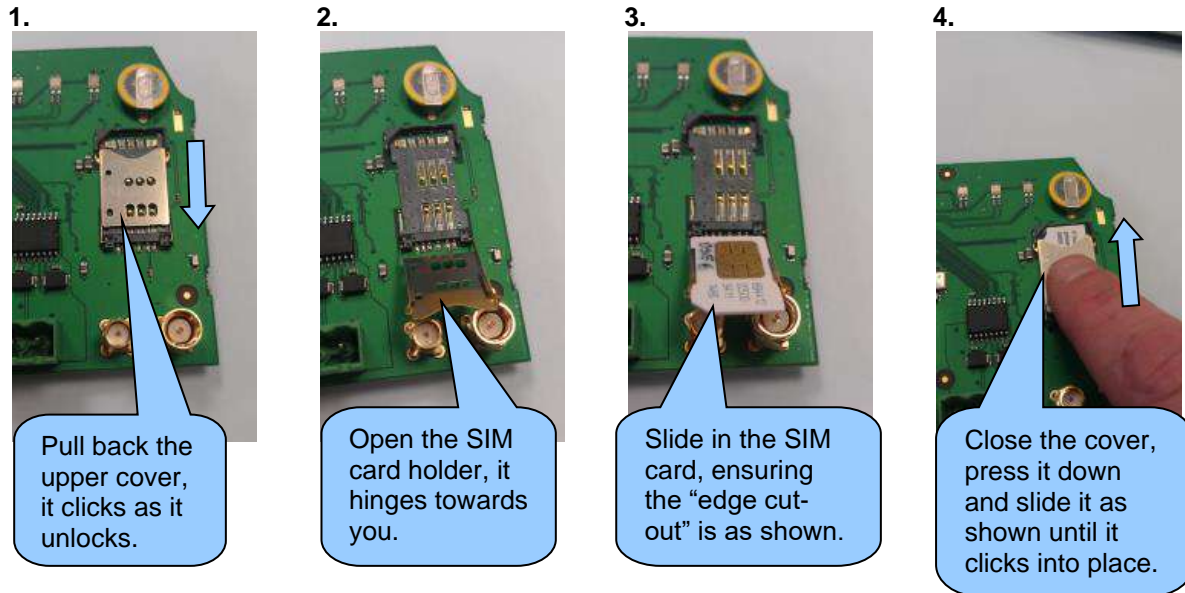

## 2.4.9 MICROSD CARD HOLDER

The microSD Card Holder is currently not utilised and is intended for future development.



## 2.5 DSEGATEWAY® CONNECTION TO SERVER

**NOTE:** The DSEGateway® must have a module connected when connecting to DSEWebNet® Server for the first time. This is not required for MQTT Broker connections.

The DSEGateway® communicates with the DSEWebNet® Server and MQTT Brokers at regular (configurable) intervals to upload its logged data to the using an internet connection.

The Internet connection is attained via the Ethernet and / or the GSM connection.

### 2.5.1 VIA ETHERNET

**NOTE:** For further details on how to configure the DSEGateway® Ethernet settings see section entitled *Network* within the *Configuration* section elsewhere in this document.

The DSEGateway® can be connected to DSEWebNet® and/or MQTT Broker via an internet router or network provided. The connection details need to be obtained via the network provider or IT manager of the associated network.

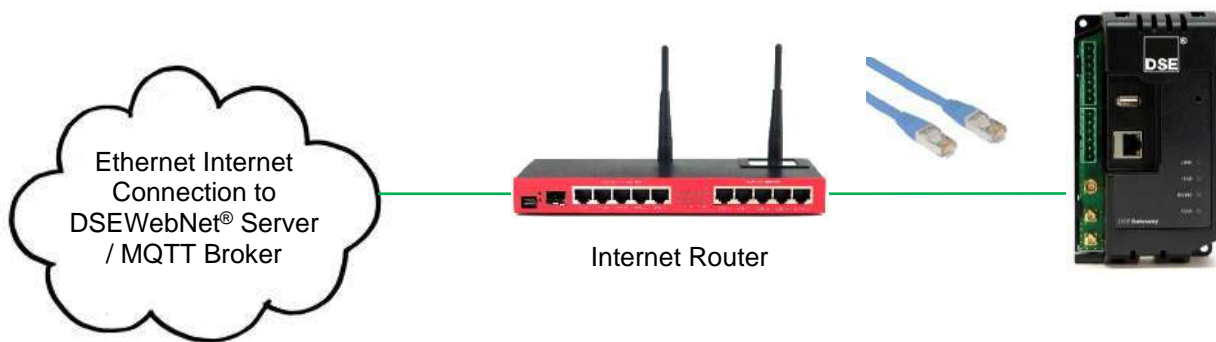

### 2.5.2 VIA GSM

**NOTE:** For further details on how to the configure the DSEGateway® GSM settings, see section entitled *GSM* within the *Configuration* section elsewhere in this document.

A 4G GSM SIM card is fitted into the DSEGateway®, this provides GRPS connection to the DSEWebNet® Server and/or MQTT Broker. The DSEGateway® is designed to work with all GSM Data enabled SIM Cards (2G, 3G, 4G). The DSEGateway® needs to be configured using the associated network settings. These settings are obtained by contacting the SIM card supplier.



## 2.5.3 DSEWEBNET®

### 2.5.3.1 SERVER CONNECTION INFORMATION

This section contains information that may be useful to the I.T. or Network Managers on sites where the DSEGateway® is installed and it is communicating with the DSEWebNet servers.

Item	Description
Transmission Protocol	<p>Data is sent to the DSEWebNet® server using HTTP (port 80), HTTPS (port 443) and WebSocket (port 83).</p> <p>All communications between the DSEGateway® and the DSEWebNet® server are initiated by the DSEGateway®. This allows bi-directional communication but ensures that the DSEGateway® does not accept incoming data from unauthorised sources, except for when the Modbus TCP passthrough has been enabled.</p> <p>All data sent from the DSEGateway® is hosted on the DSEWebNet® server and accessed using <a href="http://www.dsewebnet.com">www.dsewebnet.com</a> or the DSEWebNet® App.</p>
Data Encryption	<div style="border: 1px solid black; padding: 5px; margin-bottom: 10px;"> <p><b>▲ NOTE: In v1.## of the DSEGateway®, the data transmitted to the DSEWebNet® was not encrypted but was not human readable. In v2.## and above of the DSEGateway®, the data transmitted to the DSEWebNet® was encrypted using TLS1.2.</b></p> </div> <p>All the data is sent to the DSEWebNet® using a web socket protocol connection for real time data and http posts for historic data.</p> <p>In firmware version 1.## the data sent from the DSEGateway® to the DSEWebNet® was not encrypted, but was not human readable. i.e. numbers and letters only rather than words.</p> <p>In firmware version 2.## and above, the data sent from the DSEGateway® to the DSEWebNet® is encrypted using TLS 1.2.</p> <p>The data from the DSEWebNet® to the device (e.g. PC or Smart Phone) is encrypted using TLS encryption which prevents packet sniffing or injection. The DSEWebNet® webpage opens an outbound connection on port 443 which is the standard for TLS/SSL connections to the DSEWebNet® server.</p> <p>When the DSEGateway® is connecting to the DSEWebNet® server using GSM, the registration process uses a HTTPS connection.</p>
Access Security	<p>The users on the DSEWebNet® have a different php session with “session takeover” attack prevention taken into account.</p> <p>The passwords for the DSEWebNet® accounts are hashed in bcrypt format.</p>

### 2.5.3.2 FIREWALL SETTINGS

To allow the DSEGateway® to communicate with the DSEWebNet® Server it is important that any network firewalls do not block access to the relevant ports. This is particularly important with wired connection to the internet however usually GSM networks do not include a network firewall.

The DSE Server names and port numbers are listed below, the port number used is dependent on firmware version of the DSEGateway®.

Domain Name	Port
www.dsewebnet.com	80
gwrealtime.dsewebnet.com	83, 443
historic.dsewebnet.com	80, 443

The image below details the specific server Domain addresses shown on the DSEGateway® Network tab.

URL	IP	Status
 www.dsewebnet.com	62.128.207.153	OK
 gwrealtime.dsewebnet.com:443	62.128.207.133	RECEIVING DATA
 historic.dsewebnet.com:443	62.128.207.134	OK

To provide the best possible service, it is recommended that any firewall is configured to allow access to all subdomains on the *dsewebnet.com* domain as follows:

Domain Name	Ports
*.dsewebnet.com	80, 83, 443

## 2.5.4 MQTT

### 2.5.4.1 SERVER CONNECTION INFORMATION

This section contains information that may be useful to the I.T., Network Managers or system integrators / designers where the DSEGateway® is installed and it is communicating with the 3<sup>rd</sup> party MQTT Brokers.

Item	Description
Transmission Protocol	<p>Data is sent using standard JSON Notation for MQTT V3.1.1 (ISO/IEC 20922:2016) with support for:</p> <ul style="list-style-type: none"> <li>• MQTT V3.1.1 Brokers on local networks or Cloud based Servers (e.g. AWS, Google, IBM Watson)</li> <li>• Microsoft Azure IoT Hub Cloud based services.</li> </ul> <p>Normally data is sent to the MQTT Broker server using port 1883 (unencrypted) or 8883 (encrypted), depending on DSEGateway® configuration. However, it is possible to use any port number as this is definable within the DSEGateway® configuration.</p> <p>All communications between the DSEGateway® and the MQTT Broker are initiated by the DSEGateway®. This allows bi-directional communication but ensures that the DSEGateway® does not accept incoming data from unauthorised sources, except for when the Modbus TCP passthrough has been enabled.</p>
Security Options	<p>Depending on how the DSEGateway® is configured, the security settings for the communication to the MQTT Broker could either be:</p> <ul style="list-style-type: none"> <li>• Unencrypted and unsecure connection (advised for local connection only)</li> <li>• Unencrypted connection using MQTT Broker Username / Password (advised for local connection only)</li> <li>• TLS 1.2 encrypted connection using Server Certificate with no MQTT login credentials</li> <li>• TLS 1.2 encrypted connection using Server Certificate and MQTT Broker Username / Password</li> <li>• TLS 1.2 encrypted connection using Server and Client Certificates</li> <li>• TLS 1.2 encrypted connection using Server and Client Certificates with MQTT Broker Username / Password</li> </ul>

### 2.5.4.2 FIREWALL SETTINGS

To allow the DSEGateway® to communicate with the MQTT Broker it is important that any network firewalls do not block access to the relevant ports.

This is particularly important with wired connection to the internet however usually GSM networks do not include a network firewall.

The MQTT Broker IP address and the port number used is dependent on the configuration of the DSEGateway®. Refer to the DSEGateway® configuration settings to confirm which IP address and port number are required.

## **2.6 BROWSER COMPATIBILITY**

### **2.6.1 GOOGLE CHROME**

The DSEGateway® management pages are optimised for Google Chrome web browser.

### **2.6.2 MICROSOFT EDGE**

The DSEGateway® management pages are optimised for Microsoft Edge web browser.

### **2.6.3 INTERNET EXPLORER**

Internet Explorer is not supported by the DSEGateway® management pages.

### **2.6.4 SAFARI**

Safari is not supported by the DSEGateway® management pages.

### **2.6.5 SMARTPHONE BROWSERS**

Smartphone browsers are not supported by the DSEGateway® management pages.

## 2.7 DSE MODULE COMPATIBILITY

At the time of printing, the following devices are currently compatible with the DSEGateway® for DSEWebNet® and MQTT. For up-to-date information regarding device compatibility contact DSE technical support:

Tel: +44 1723 890099

Fax: +44 1723 893303

Email: support@deepseaelectronics.com

<b>DSE Module</b>
DSE334
DSE335
DSEE100
DSEE400
DSEE800
DSEL400
DSEL401, DSEL401 MKII
DSEP100
DSE4310, DSE4310 NC
DSE4320, DSE4320 NC
DSE4410 CAN, DSE4410 MPU
DSE4420 CAN, DSE4420 MPU
DSE4510, DSE4510 NC, DSE4510 RT, DSE4510 RTH, DSE4510 MKII
DSE4520, DSE4520 NC, DSE4520 RT, DSE4520 RTH, DSE4520 MKII
DSE4610, DSE4610 RTH
DSE4620, DSE4620 RTH
DSE6010 CAN, DSE6010 MPU, DSE6010 MKII
DSE6020 CAN, DSE6020 MPU, DSE6020 MKII
DSE6110 CAN, DSE6110 MPU, DSE6110 MKII, DSE6110 MKIII
DSE6120 CAN, DSE6120 MPU, DSE6120 A3, DSE6120 MKII, DSE6120 MKIII
DSE7110, DSE7110 MKII
DSE7120, DSE7120 MKII
DSE7210
DSE7220
DSE7310, DSE7310 MKII
DSE7320, DSE7320 MKII
DSE7410, DSE7410 MKII
DSE7420, DSE7420 MKII
DSE7450
DSE8610, DSE8610 MKII
DSE8620, DSE8620 MKII
DSE8660, DSE8660 MKII
DSE8710
DSE8760
DSE8810
DSE8860
DSE8910
DSE8920
DSEG8600
DSEG8660
DSEG8680

### 3 QUICK SET UP GUIDE FOR DSEWEBNET®

 **NOTE:** Consult the company IT department before making changes to the PC's network settings. Ensure to make a note of any settings before changing them so they are restorable after the set up procedure. Refer to section entitled *Firewall Settings* elsewhere within this document for URL and TCP Port requirements for internet connection.

 **NOTE:** To access DSEWebNet®, a user account is required. For further details on how to Register and Login to a DSEWebNet® account, refer to DSE publication *057-168 DSEWebNet® Software Manual* available from the DSE website at [www.deepseaelectronics.com](http://www.deepseaelectronics.com).

The following Quick Set Up Guide is intended to assist configuring the DSEGateway® and connecting to DSEWebNet®.

#### 3.1 PREREQUISITES

Before attempting to set up a DSEGateway®, ensure the following prerequisites:

1. Have a PC with an ethernet port and an ethernet cable.
2. Be able to change the PC's network settings, such as the IP address.
3. Have the DSEGateway® correctly installed and connected to the DSE module by USB.

### 3.2 STEP ONE: CONNECT AND CONFIGURE THE DSEGateway®

**NOTE:** Consult the company IT department before making changes to PC network settings.

1. Connect the DSEGateway® Ethernet port directly to the PC Ethernet port using either a 'straight through' or 'crossover' network cable.
2. Configure your PC to be on a fixed IP address (192.168.1.99) as per below...

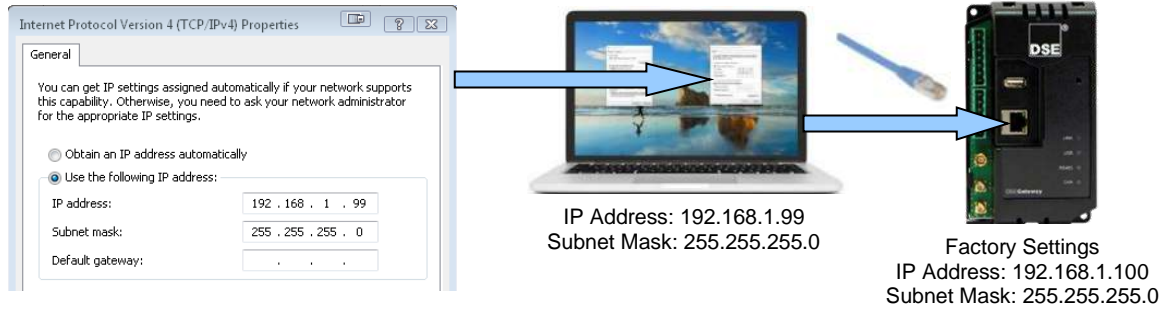

3. Using Google Chrome or Microsoft Edge, navigate to the address of the DSEGateway® (192.168.1.100) and enter the username and password of the DSEGateway®... The DSEGateway® password must be changed on first login.

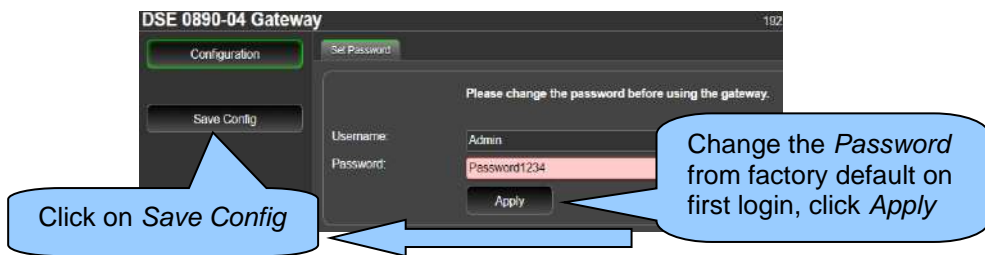
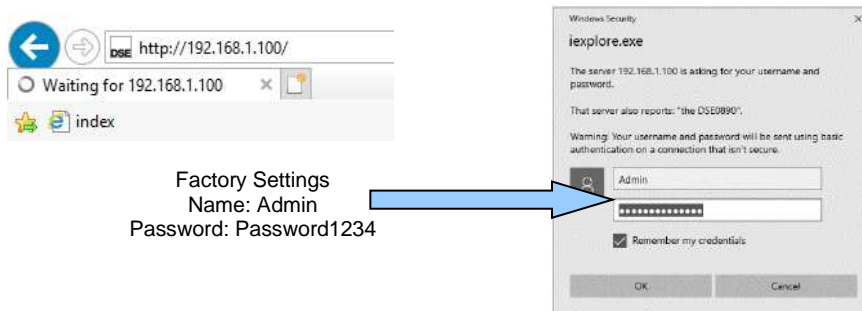

4. It is now possible to view and configure the DSEGateway®. Make a note of the DSEGateway® ID number. This is required when adding the DSEGateway® to DSEWebNet®.



### 3.3 STEP TWO: CONNECT THE MODULE

**NOTE:** The DSEGateway® is configured to connect to a DSE Module via the USB port. If this is not the communication type to be used, see section entitled *Modules Connection* elsewhere within this document.

**NOTE:** DSE advise against the use of USB when used in close proximity to sources of electromagnetic interference.

Connect the DSEGateway® to the associated DSE modules as shown below...

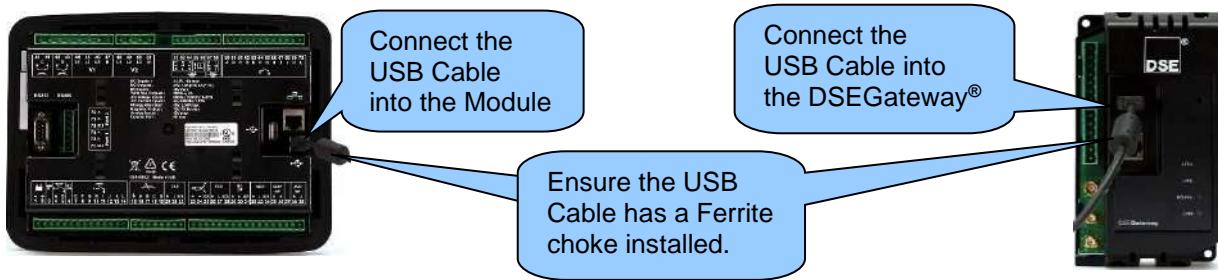

#### Cable Specification

Description	Specification
USB Cable	USB 2.0 type A to type B screened cable (sometimes known as 'printer cable') with ferrite choke. Max distance 5 m (16 feet).

### 3.4 STEP THREE: CONFIGURE THE INTERNET CONNECTION

**NOTE:** GSM settings are obtainable by contacting the phone network provider or checking the SIM card packaging.

**NOTE:** For further details on how to configure the GSM connection see section entitled *Configuration GSM* elsewhere within this document. For further details on how to configure the ethernet connection see section entitled *Configuration* elsewhere within this document.

Configure the DSEGateway® to suit the phone or network requirements. These requirements vary according to the SIM Card provider.

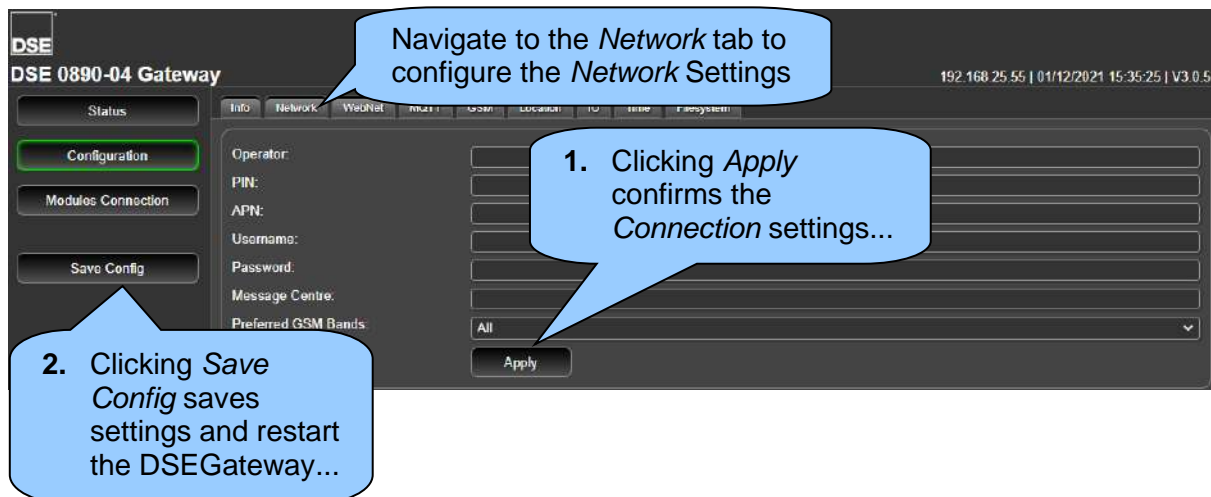

### 3.5 STEP FOUR: CHECK CONNECTION

**NOTE:** The DSEGateway® must have a DSE Module connected when connecting to DSEWebNet® for the first time.

Ensure the DSEGateway® has connected to the DSEWebNet® servers by checking the *Status | WebNet* diagnostic tab located in the DSEGateway® browser.

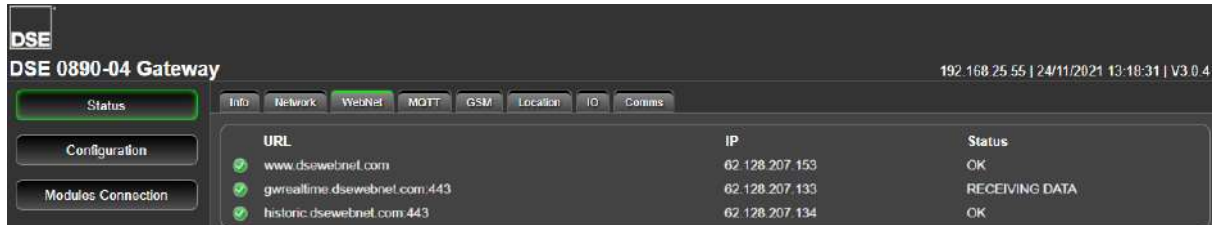

#### Typical Connection Process

Upon connection to the Internet the DSEGateway® attempts to connect to the DSEWebNet® Servers. The process is as follows...

1. Upon completion of *Step Three: Configure The Internet Connection*, the DSEGateway® reboots.
2. For a short time (up to 5 mins), the *LINK* LED remains red.
3. The *LINK* LED illuminates green when connection to the DSEWebNet® server is established.
4. The DSEGateway® configures itself for the connected DSE module, after a short period the USB LED begins to flash.
5. The DSEGateway® and DSE module are now ready to be added to DSEWebNet®.

### 3.6 STEP FIVE: ADD THE DSEGateway® TO DSEWEBNET®

**NOTE:** To access DSEWebNet®, a user account is required. For full details on how to Register and Login to DSEWebNet® account please see manual *DSEWebNet® 057-168*.

To add a DSEGateway® to the user's account, the *Gateway USB ID* and *Security Code* are required. This information is located in the DSEGateway® Status Configuration screens.

The DSEGateway® USB ID is located under the *Status Info* section of the DSEGateway® configuration.

The Security Code is located under the *Configuration Info* section of the DSEGateway® configuration.

1. Launch a compatible internet browser and navigate to the website: [www.dsewebnet.com](http://www.dsewebnet.com) and login into DSEWebNet®.
2. Click on *Manage Gateways and Modules* located on the top right hand corner of the webpage. The *Devices* section of the *Account Settings* is opened.

Click to add or remove a DSE module to the DSEWebNet®

3. To add a DSEGateway® to the account, click the *Plus* button located on the top right hand corner of the webpage. The *Add New Gateway* option is opened
4. Enter the DSEGateway® USB ID and Password

Click to continue

5. Select the Module to be added. DSEWebNet® uses the Module's *USB ID*.

Select the DSE Module(s) to be added to the DSEWebNet®.

Enabled	Module USB ID	Name
<input checked="" type="checkbox"/>	213657710	
<input checked="" type="checkbox"/>	213AE33CA	Gen 1
<input checked="" type="checkbox"/>	213AE348A	Gen 2
<input checked="" type="checkbox"/>	67FFFF713D	Gen 3
<input type="checkbox"/>	3194EE0D4	3194EE0D4
<input type="checkbox"/>	31F61C26D	31F61C26D
<input type="checkbox"/>	619D84F73	619D84F73

USB ID of the DSE Module(s) that are, or have been connected to the DSEGateway®

Save the changes that have been made

## 4 CONTROLS AND INDICATIONS

The DSEGateway<sup>®</sup> facia has four indication LED's as well as a Reset button.

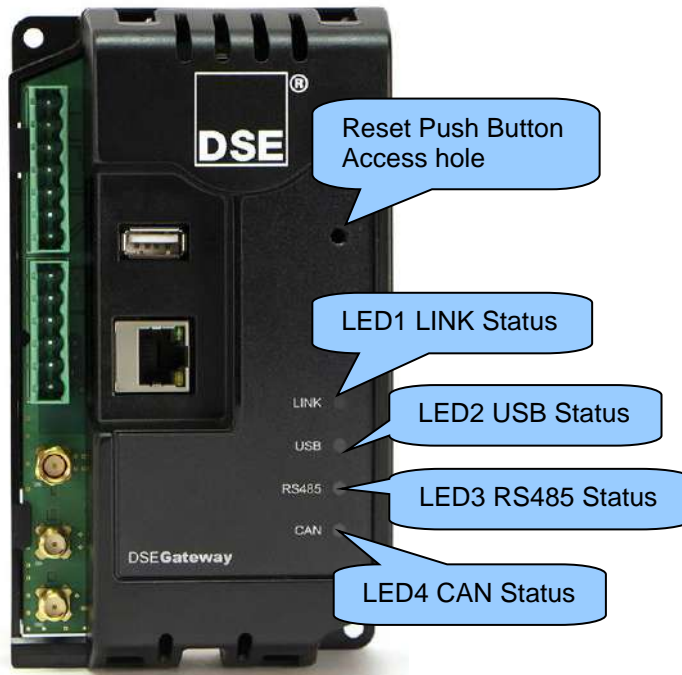

### 4.1 RESET PUSHBUTTON

**NOTE:** If the DSEGateway<sup>®</sup> has the *Allow Factory Reset* option disabled, pressing and holding the *Reset Pushbutton* does not reset the DSEGateway<sup>®</sup> back to default settings.

The Reset pushbutton is accessible by removing the front cover or by accessing the small hole on the DSEGateway<sup>®</sup> facia. The Reset pushbutton is used to both power cycle the DSEGateway<sup>®</sup> and reset the DSEGateway<sup>®</sup> back to factory settings. Briefly pressing and releasing the Reset Pushbutton reboots the gateway. Pressing and holding the Reset Pushbutton resets the DSEGateway<sup>®</sup> back to factory settings if possible: The resultant procedure is as follows...

1. Press and hold the *Reset* pushbutton.
2. All LEDs illuminate yellow.
3. All LEDs extinguish for a short time.
4. Release the *Reset* pushbutton.
5. LEDs illuminate one at a time – LED1, LED2, LED3, LED4.
6. All LEDs illuminate yellow for a very short time.
7. Reset has completed, now release the reset push button.

Once reset, the DSEGateway<sup>®</sup> must be reconfigured. Refer to section entitled *Quick Reference Guide* elsewhere in this document for further details.

If the DSEGateway<sup>®</sup> has the *Allow Factory Reset* option disabled, and the Reset pushbutton is held down the unit does not reset back to factory settings. The resultant procedure is as follows...

1. Press and hold the *Reset* pushbutton.
2. All LEDs illuminate yellow initially for a short time
3. All LEDs illuminate red for a short time instead of turning off.
4. Reset has not been allowed, returns to normal operation when the *Reset* pushbutton is released.

## 4.2 LED INDICATIONS

LED	Function	Colour	Action
1	LINK Status	Red	<p>The Link LED is red:</p> <ul style="list-style-type: none"> <li>• If connection to the DSEWebNet and MQTT Broker are disabled and passthrough is not receiving data in intervals of 30 seconds or less.</li> <li>• If connection to the DSEWebNet is disabled but connection to the MQTT Broker is enabled but not connected.</li> <li>• If connection to the DSEWebNet is enabled but not connected, irrespective if the MQTT Broker connection is enabled.</li> </ul>
		Green	<p>The Link LED is Green:</p> <ul style="list-style-type: none"> <li>• If connection to the DSEWebNet is disabled but connection to the MQTT Broker is enabled and is established.</li> <li>• If connection to the DSEWebNet is enabled and established, irrespective if the MQTT Broker connection is enabled or pass.</li> <li>• If connection to the DSEWebNet, and MQTT Broker are disabled but passthrough is receiving data in intervals of 30 seconds or less.</li> </ul>
2	USB Status	Off	Communication port not enabled
		Red	Communication port enabled but data transfer not working
		Green	Communication port enabled and data transfer is working.
3	RS485 Status	Off	Communication port not enabled
		Red	Communication port enabled but data transfer not working
		Green	Communication port enabled and data transfer is working.
4	CAN Status	Off	Communication port not enabled
		Red	Communication port enabled but data transfer not working
		Green	Communication port enabled and data transfer is working.

## 5 USER PAGES

The DSEGateway® is setup and configured using a PC with web browser and a 'straight through' or 'crossover' network cable.

### 5.1 CONNECTING TO THE DSEGateway® MANAGEMENT PAGES

**NOTE:** Consult the company IT department before making changes to the PC's network settings.

**NOTE:** The following guide refers to the default settings for the DSEGateway®, refer to installer for further details.

1. Connect the DSEGateway® Ethernet port directly to the PC Ethernet port using either a 'straight through' or 'crossover' network cable.
2. Configure your PC to be on a fixed IP address (192.168.1.99) as per below ...

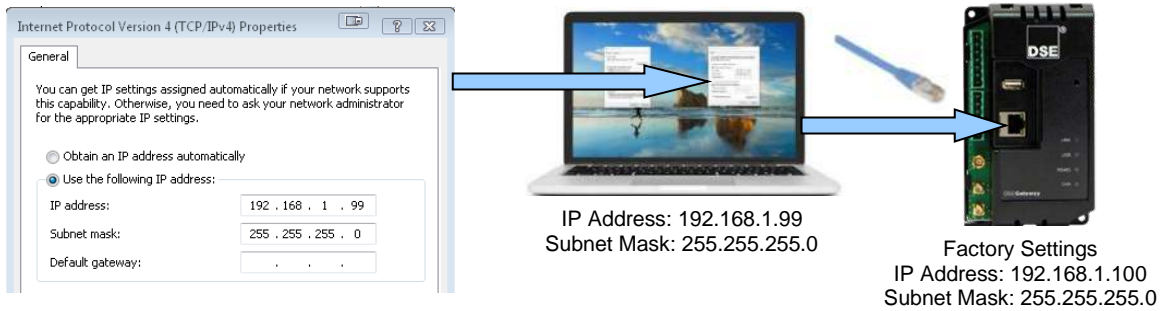

3. Using Google Chrome or Internet Explorer, navigate to the address of the DSEGateway® (192.168.1.100) and enter the username and password of the DSEGateway®...

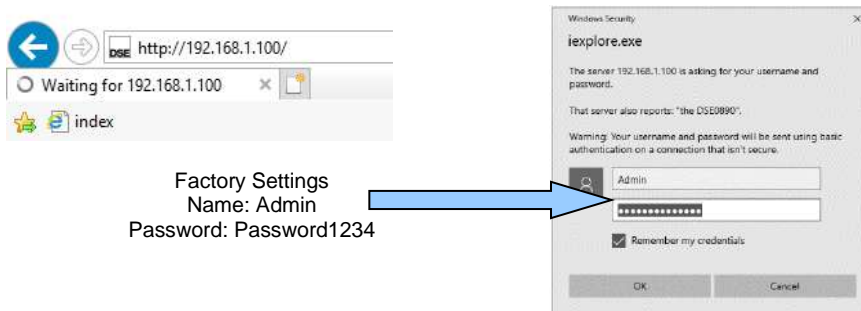

4. It is now possible to view and configure the DSEGateway®. Make a note of the DSEGateway® ID number. This is required when adding the DSEGateway® to DSEWebNet®.



## 5.2 STATUS

The *Status* pages show information that is be used for diagnostics and give a level of confidence that the system is working as expected. Along with DSEGateway® software information, it also indicate the state of the various communication ports in use.

The information is separated into subtabs:



### 5.2.1 INFO

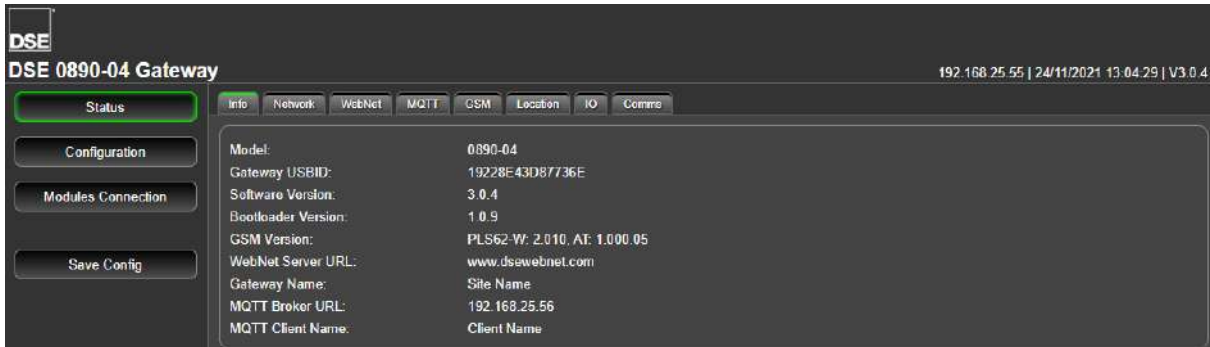

Parameter	Description
Model	The model number of the DSEGateway®.
Gateway USBID	The identification number of the DSEGateway®. This is used when adding the DSEGateway® to the DSEWebNet® Server.
Software Version	The software version of the DSEGateway®.
Bootloader Version	The software bootloader version of the DSEGateway®.
GSM Version	The GSM version of the DSEGateway®.
WebNet Server URL	Shows the configured address that the DSEGateway® uses to communicate to DSEWebNet® Server with, www.dsewebnet.com.
Gateway Name	The name of the DSEGateway® as it appears on the DSEWebNet. This is configured under <i>Configuration Info</i> tab.
MQTT Broker URL	Shows the configured address that the DSEGateway® uses to communicate to an external third party MQTT Broker with.
MQTT Client Name	The name of the DSEGateway® as it appears to the external third party MQTT Broker.

## 5.2.2 NETWORK

The *Status>Network* page is divided up into smaller sub-sections.

### Network Settings

Shows the current network settings in use on the DSEGateway®

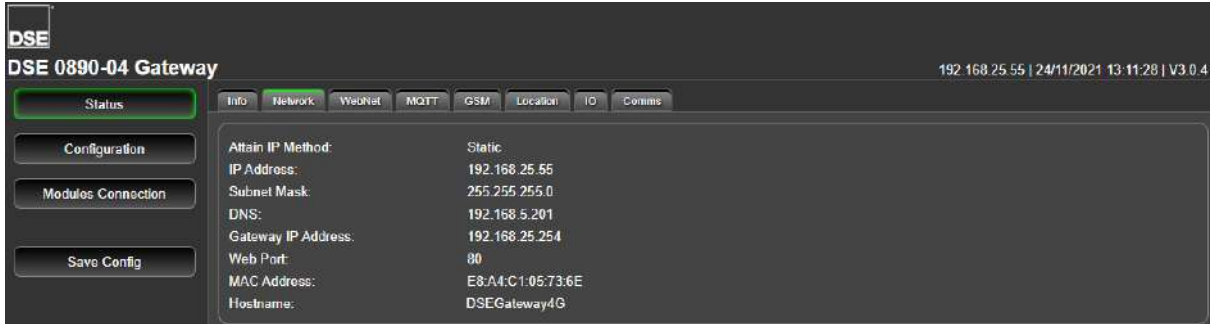

Parameter	Description
Attain IP Method	Shows the type of IP address assigned to the DSEGateway® Ethernet Port. <b>Static:</b> Static IP address, manually entered. <b>DHCP:</b> IP address assigned by the network DHCP server.
IP Address	IP address currently being used by the DSEGateway®'s Ethernet Port.
Subnet Mask	Subnet Mask for the DSEGateway®'s Ethernet Port.
DNS	DNS (Domain Name Service) setting for the DSEGateway®'s Ethernet Port.
Gateway IP Address	The IP address location of the internet router currently used by the DSEGateway®'s Ethernet Port to communicate with the DSEWebNet® Server.
Web Port	The TCP Port Number currently in use by the DSEGateway®'s Ethernet Port to serve the Web Management Pages.
MAC Address	Unique Hardware Identification number of the DSEGateway®'s Ethernet Port.
Hostname	Shows the currently configured Hostname of the DSEGateway®'s Ethernet Port.

**Log Level (Diagnostics)**

This page shows diagnostic information that may assist DSE Technical Support in the case of connection issues. The information displayed relates to DSEGateway® sent and received commands between the Modules, the DSEWebNet® Servers and the phone network.

Selecting differing log levels allows you to filter the messages

Example showing a successful connection to the DSEWebNet® server using GSM

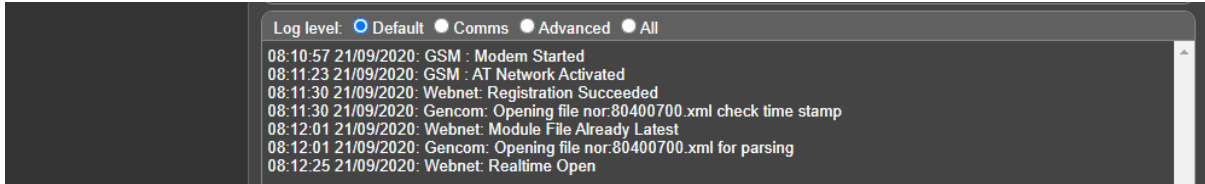

Parameter	Description
Log Level	<p>Selecting differing log levels allows the user to see specific diagnostic and status information. Unless advised by DSE Technical Support it is recommended to leave the <i>Log Level</i> configured as <i>Default</i></p> <ul style="list-style-type: none"> <li>⊙ <b>Default:</b> The messages shown reference all connection status messages between the DSEWebNet® Servers / MQTT Brokers and any associated DSE Modules.</li> <li>⊙ <b>Comms:</b> The messages shown reference status messages that relate to the DSEWebNet® servers / MQTT Brokers only.</li> <li>⊙ <b>Advanced:</b> This mode is for DSE Technical support use only.</li> <li>⊙ <b>All:</b> This mode is for DSE Technical support use only.</li> </ul>

### 5.2.3 WEBNET

#### URL

Shows the current status of the connection to the DSEWebNet® servers.

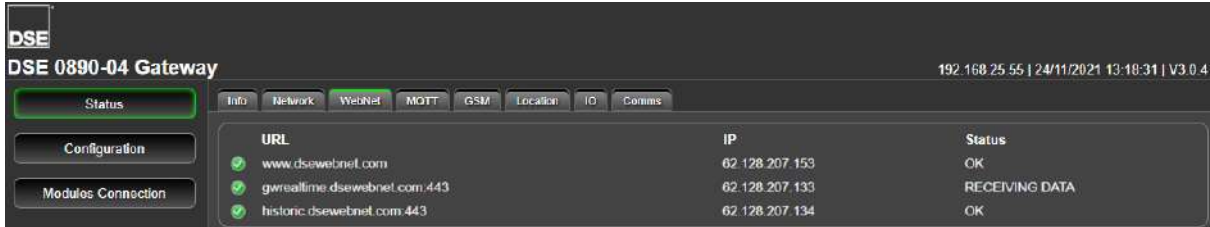

Parameter	Description
URL, IP, Status	Shows the status of connection to the DSEWebNet® Server. = The connection is made to the respective port of the DSEWebNet® Server. = The respective port of the DSEWebNet® Server cannot be reached. This may be a local firewall issue.

#### Stats

**NOTE:** Statistics vary according to the DSE Module connection *Data Resolution* configuration. For further details, refer to section entitled *Modules Connection* elsewhere within this document.

Shows the amount of data sent and received by the DSEGateway® to the DSEWebNet® server.

All data is buffered within in the DSEGateway® memory until such a point that the data is required to be sent to the DSEWebNet® servers. The frequency of transmission varies according to the DSEGateway® Module *Data Resolution* configuration as well as signal strength and network quality. Data is also buffered during a loss of connection. This is useful when determining if the correct package has been purchased from the SIM Card or internet provider.

The DSEGateway® connects to two different servers. These are referred to as the Realtime and Historic servers. The Realtime server handles all live data such as battery voltage, fuel level, live voltage etc. The Historic server handles events which is used for Event Triggers and Reports. The parameters below detail the statistic between the DSEGateway® and the DSEWebNet® Servers.

The screenshot shows a dark-themed interface with the following metrics:

- Realtime Response: 0 ms
- Realtime Average Response: 0 ms
- Active Percent: 0.0%
- Active Actual: 0 B
- History Percent: 0.0% (0)
- History Actual: 0 kiB
- Total History: 0 kiB
- Total Realtime: 0 kiB

Below the metrics are two 'Reset' buttons. The first is labeled 'Reset Realtime Counter' and the second is labeled 'Reset Historic Counter'. Two callout boxes provide the following text:

- Top Callout:** Click to reset the count of data sent to the *realtime.dsewebnet.co.uk* server. This is data sent while a user is viewing the DSEGateway® on the DSEWebNet® system.
- Bottom Callout:** Click to reset the count of data sent to the *historic.dsewebnet.co.uk* server. This is data sent by the DSEGateway® to the DSEWebNet® system as part of its *Historic Data* uploads (when configured).

Parameter	Description
Realtime Response	The time taken to send a message to the DSEWebNet® server and get a response. This gives an indication of how good the connection is. A typical response on Ethernet should be less than 100 ms. A typical response on GSM should be less than 2000 ms.
Realtime Average Response	The average speed of response between the DSEGateway® and the DSEWebNet® Realtime server since the connection was established. This gives an indication of how good the connection is. A typical response on Ethernet should be less than 100 ms. A typical response on GSM should be less than 2000 ms.
Active Percent	The total percentage of the Realtime data buffer used. The Realtime buffer only accumulates if there is a connection to the DSEWebNet® Realtime server. All data is discarded if the connection is lost. If the Realtime buffer reaches 100%, the DSEGateway® replaces the oldest data with the newest data. This occurs if too much data is trying to be transmitted, change the <i>Data Resolution</i> setting to <i>Low</i> or <i>Snapshot</i> with a long interval.
Active Actual	The total data stored within the Realtime buffer. This is used for diagnostics by DSE Technical Support.
History Percent	The total percentage of the historic data buffer used. The historic buffer accumulates if there is a connection to the DSEWebNet® historic server. If the connection is lost, the DSEGateway® continues to buffer the historic data for 5 minutes before discarding the data. If the historic buffer reaches 100%, the DSEGateway® replaces the oldest data with the newest data. This occurs if too much data is trying to be transmitted, reduce the <i>Historic Upload Interval</i> or change the <i>Data Resolution</i> setting to <i>Low</i> or <i>Snapshot</i> with a long interval.
History Actual	The total data stored within the Historic buffer. This is used for diagnostics by DSE Technical Support.
Total History	The Total amount of Historic data sent from the DSEGateway®. This combined with the <i>Total Real-time</i> data value is useful to estimate the size of data package required.
Total Real-time	The Total amount of Realtime data sent from the DSEGateway®. This combined with the <i>Total History</i> data value is useful to estimate the size of data package required.

### 5.2.4 MQTT

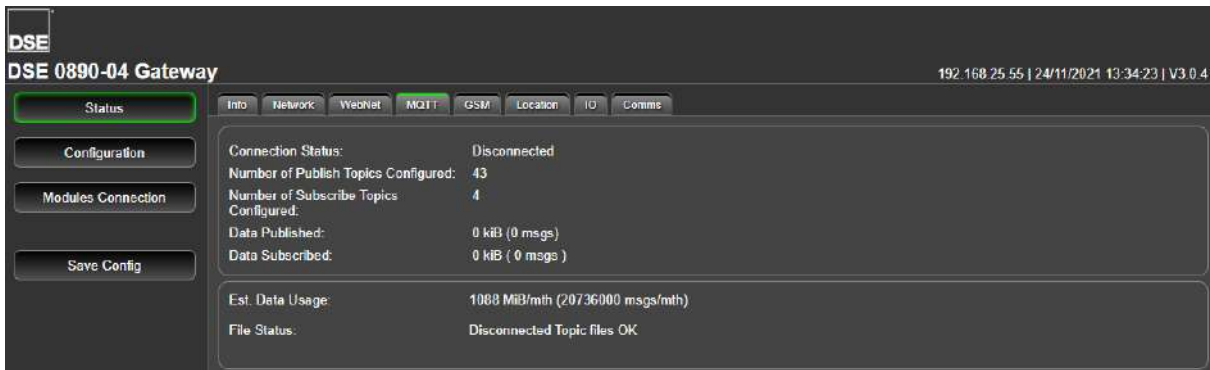

Parameter	Description
Connection Status	Shows the status of connection to the external third party MQTT Broker.
Number of Publish Topics Configured	The total number of topics that have been configured in all the DSE modules' topic files to be published to the MQTT Broker. For further details, refer to section entitled Modules Connection elsewhere in this document.
Number of Subscribe Topics Configured	The total number of topics that have been configured in all the DSE modules' topic files to be subscribed to from the MQTT Broker. For further details, refer to section entitled Modules Connection elsewhere in this document.
Data Published	The total amount of data and messages published by the DSEGateway® to the external third party MQTT Broker.
Data Subscribed	The total amount of data and messages received by the DSEGateway® from the external third party MQTT Broker.
Est. Data Usage:	The total estimated MQTT Published data usage per month for all the configured topics for all the connected devices. MQTT Subscribed data is not included in this estimation.
File Status:	Shows the status / errors for the MQTT Topic files uploaded to the DSEGateway®.

### 5.2.5 GSM

Provides diagnostic information for the GSM connection.

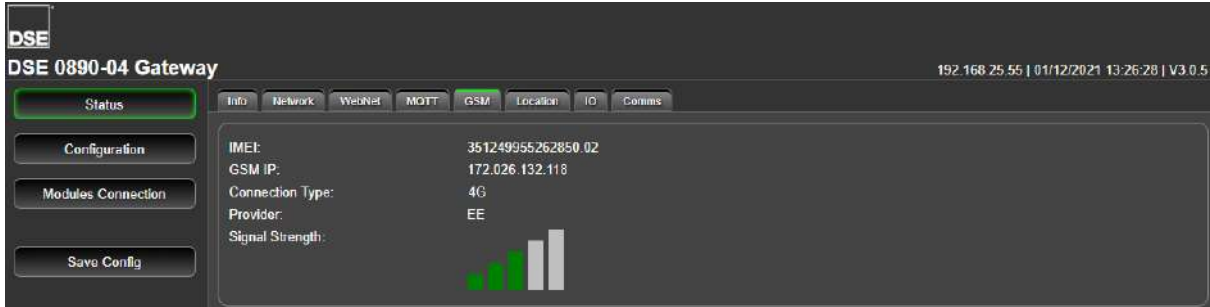

Parameter	Description
IMEI	IMEI number of the GSM communications device integrated within the DSE890 DSEGateway®.
GSM IP	IP address obtained from the GSM network provider. Unless a specifically purchased fixed IP address has been obtained from the SIM card provider, this number is dynamically provided by the GSM network operator.
Connection Type	Type of connection made to the GSM network. This changes from area to area depending upon local network provision.
Provider	The name of the GSM network currently connected.
Signal Strength	A representation of the GSM signal strength. This does not represent the quality of the GSM (cellular internet) connection. No green bars indicates poor reception. Move the antenna to a better location.

### 5.2.6 LOCATION

Shows the current location of the DSEGateway®.

This is either a fixed or GPS devised location, depending upon configuration. When configured to Use GPS location the DSEGateway® requires a connection a minimum of 3 satellites.

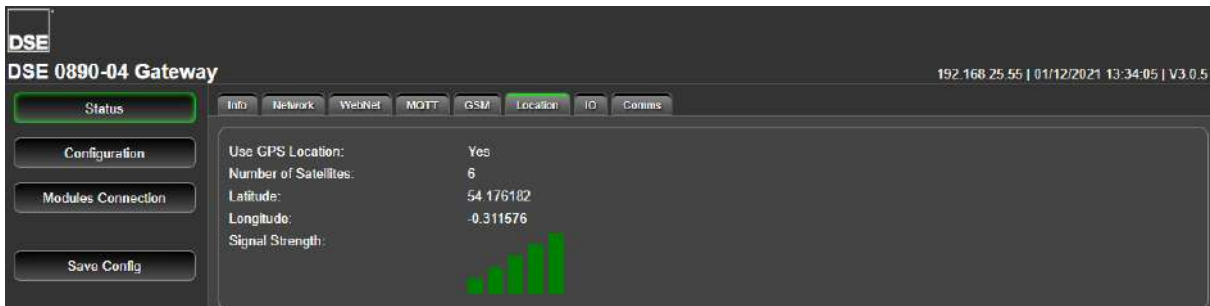

Parameter	Description
Use GPS Location	Indicates if the DSEGateway® is configured to use the GPS antenna to determine the location. For further details refer to section entitled <i>Configuration</i> elsewhere in this manual.
Number of Satellites	The number of satellites the DSEGateway® has connection to determine the global position of the device. Connection to at least 4 satellites is required to antenna a location.
Latitude	The latitude of the location the DSEGateway® is using. This is determined from the GPS or from the pre-determined location.
Longitude	The longitude of the location the DSEGateway® is using. This is determined from the GPS or from the pre-determined location.
Signal Strength	A representation of the GPS signal strength. No green bars indicate poor reception. Move the GPS antenna to a better location.

### 5.2.7 I/O

Shows the state of the DSEGateway® I/O (Inputs/Outputs). These are configured in the *Configuration | I/O* tab.

DSE 0890-04 Gateway 192.168.25.55 | 01/12/2021 13:45:52 | V3.0.5

Info Network WebNet MQTT GSM Location **I/O** Comms

Index	Name	I/O	Status
1	Digital In 1	In	<input type="radio"/>
2	Digital In 2	In	<input type="radio"/>
3	Digital Out 1	Out	<input type="radio"/>
4	Digital Out 2	Out	<input type="radio"/>

### 5.2.8 COMMS

Shows the status of the data transfer between the DSEGateway® and the connected Module(s). When operating correctly, the packets *Received* increment as the packets *Sent* increase. Unconfigured ports show 0 (zero) for both *Sent* and *Received* as no communications takes place.

DSE 0890-04 Gateway 192.168.25.55 | 01/12/2021 13:47:48 | V3.0.5

Info Network WebNet MQTT GSM Location I/O **Comms**

Comms method	Direction	Packets
USB Host	Sent	21919
	Received	21919
RS485	Sent	0
	Received	0
TCP Host	Sent	0
	Received	0
J1939	Sent	0
	Received	0

### 5.3 CONFIGURATION

The *Configuration* pages allow the User to configure the DSEGateway® to suit the application.

Upon changing a parameter on any of the pages, the *Apply* button must be pressed before exiting the current page. This stores the new settings and allows settings on other pages to be changed. A new button, *Save Config* becomes available after *Apply* is clicked.

The screenshot shows the configuration page for a DSE 0890-04 Gateway. The interface includes a sidebar with buttons for 'Status', 'Configuration' (highlighted), 'Modules Connection', and 'Save Config'. The main area has tabs for 'Info', 'Network', 'WebNet', 'MQTT', 'GSM', 'Location', 'IO', 'Time', and 'Filesystem'. The 'Info' tab is active, showing fields for 'Username' (Admin), 'Password' (Password1234), and 'Site Name' (DSEGateway4G). There is a checkbox for 'Allow Factory Reset' which is checked, and an 'Apply' button. Two callouts provide instructions: '1. Clicking Apply confirms the DSEGateway® settings...' and '2. Clicking Save Config saves settings and restart the DSEGateway®...'.

5.3.1 INFO

**NOTE:** For increased security, it is advised that the *Username* and *Security Code* are changed from their default settings.



Parameter	Description
Username	<p><b>NOTE:</b> Username is CASE SENSITIVE.</p> <p>Factory setting: Admin</p>
Security Code	<p><b>NOTE:</b> Security Code is CASE SENSITIVE.</p> <p><b>NOTE:</b> On the first login to the DSEGateway®, the user is prompted to change the password from the default setting.</p> <p>Factory setting: Password1234 The <i>Security Code</i> is required to gain access to these management pages and also to add connected devices to the DSEGateway®.</p>
Site Name	A name to easily identify the site. This name is shown when viewing the map of sites on the DSEWebNet® server.
Allow Factory Reset	<p><input type="checkbox"/> = Holding down the reset button for 5 seconds does not reset the DSEGateway®. This also prevents the DSEGateway® security code being reset back to factory defaults.</p> <p><input checked="" type="checkbox"/> = Holding down the reset button for 5 seconds resets the DSEGateway® back to its factory settings.</p>

### 5.3.2 NETWORK

**NOTE:** Consult with the IT/Network manager of the site that the DSEGateway® is connected to before making any changes to these settings.

Use this page to Configure the Network settings that the DSEGateway® is connecting to.

The screenshot shows the DSE Gateway configuration page for 'DSE 0890-04 Gateway'. The 'Network' tab is selected. The configuration fields are as follows:

- DHCP Enabled:
- Static IP: 192.168.25.55
- Subnet Mask: 255.255.255.0
- Gateway IP: 192.168.25.254
- DNS IP: 192.168.5.201
- Hostname: DSEGateway4G
- Web Config Port: 80
- Discovery Enabled:

Buttons for 'Apply' and 'Shell' (with an 'Enable' sub-button) are visible at the bottom.

Parameter	Description
DHCP Enabled	Set how the IP address is assigned to the DSEGateway® Ethernet Port. <input checked="" type="checkbox"/> = The DSEGateway® requests network settings from a DHCP server. <input type="checkbox"/> = The DSEGateway®'s network settings must be entered manually.
Static IP	IP address currently being used by the DSEGateway®'s Ethernet Port (Factory Setting 192.168.1.100).
Subnet Mask	Subnet Mask for the DSEGateway®'s Ethernet Port. (Factory Setting 255.255.255.0).
Gateway IP	The IP address location of the internet router currently used by the DSEGateway®'s Ethernet Port to communicate with the DSEWebNet® Server (Factory Setting 192.168.1.253).
DNS IP	DNS (Domain Name Service) setting for the DSEGateway®'s Ethernet Port (Factory set to Google DNS IP 8.8.8.8).
Hostname	Shows the currently configured Hostname of the DSEGateway®'s Ethernet Port.
Web Config Port	The TCP Port Number currently in use by the DSEGateway®'s Ethernet Port to serve the Web Management Pages.
Discovery Enabled	<div style="border: 1px solid black; padding: 5px; margin-bottom: 10px;"> <p><b>NOTE:</b> When using <i>Discovery Enabled</i>, ensure that the PC has permissions for listening to UDP sockets for public networks.</p> </div> <input checked="" type="checkbox"/> = The DSEGateway® is discoverable by the DSE Configuration Suite PC Software by going to <i>Tools   Manage Gateways</i> . This enables the user to scan the local network for connected DSEGateways® and launch their web configuration pages without changing the IP address of the PC. <input type="checkbox"/> = The DSEGateway®'s is not discoverable by the DSE Configuration Suite PC Software. Accessing the DSEGateway®'s is only achievable by manually changing the PC's network settings.
Shell	Enables <i>Advanced</i> diagnostics mode. Contact DSE Technical Support for more information.

### 5.3.3 WEBNET

Use this page to Configure the DSEWebNet settings that the DSEGateway® is connecting to.

The screenshot shows the configuration interface for a DSE Gateway. The page title is 'DSE 0890-04 Gateway'. On the left, there are navigation buttons: 'Status', 'Configuration' (highlighted with a green border), 'Modules Connection', and 'Save Config'. At the top, there are tabs for 'Info', 'Network', 'WebNet', 'MOTT', 'GSM', 'Location', 'IO', 'Time', and 'Filesystem'. The 'WebNet' tab is active. The configuration area contains two fields: 'Server URL' with the value 'www.dsewebnet.com' and 'Connection Method' with a dropdown menu set to 'Auto'. An 'Apply' button is located below the 'Connection Method' dropdown. In the top right corner, the IP address '192.168.25.55' and the date/time '01/12/2021 14:03:20 | V3.0.5' are displayed.

Parameter	Description
Server URL	Address of the DSEWebNet® server. The DSEWebNet® Server is located at <a href="http://www.dsewebnet.com">www.dsewebnet.com</a> .
Connection Method	<p><b>Auto:</b> The DSEGateway® connection method to the DSEWebNet® automatically switches <i>GSM</i> or <i>Ethernet</i> depending on which connection is available. When both connections methods are available the DSEGateway® connects to the DSEWebNet® via Ethernet.</p> <p><b>GSM:</b> The DSEGateway® connection method to the DSEWebNet® is via <i>GSM</i>.</p> <p><b>Ethernet:</b> The DSEGateway® connection method to the DSEWebNet® is via <i>Ethernet</i>.</p>





### 5.3.4 MQTT

Use this page to Configure the MQTT settings that the DSEGateway® is connecting to.

The screenshot shows the MQTT configuration interface for the DSE 0890-04 Gateway. The interface includes a navigation menu on the left with options like Status, Configuration, Modules Connection, and Save Config. The main configuration area has tabs for Info, Network, WebNet, MQTT, GSM, Location, IO, Time, and Filesystem. The MQTT tab is active, showing fields for Broker URL, Port (with an 'Automatic' checkbox), Connection Method (set to Ethernet), Clean Session on Connect (checked), MQTT Keep Alive (60), Group Name (DSE), Client Name (Client Name), Username, Password, and checkboxes for Use Login Credentials, Use Secure MQTT (checked), and Use Client Certificate. There are also 'Apply', 'Upload' buttons for Client Certificate, and 'Upload' buttons for CA Certificate.

Parameter	Description
Broker URL	Address of the <i>MQTT Broker</i> server that the DSEGateway® connects to.
Port	The port the DSEGateway® uses to communicate to the MQTT Broker. <input checked="" type="checkbox"/> = The DSEGateway® automatically selects the port used based on the <i>Use Secure MQTT</i> parameter. When <i>Use Secure MQTT</i> is enabled the port used is 8883, when <i>Use Secure MQTT</i> is disabled the port used is 1883. <input type="checkbox"/> = The DSEGateway®s uses the configured port for all communication to the MQTT Broker.
Connection Method	<b>Auto:</b> The DSEGateway® connection method to the MQTT Broker automatically switches <i>GSM</i> or <i>Ethernet</i> depending on which connection is available. When both connections methods are available the DSEGateway® connects to the MQTT Broker via Ethernet. <b>GSM:</b> The DSEGateway® connection method to the <i>MQTT Broker</i> is via <i>GSM</i> . <b>Ethernet:</b> The DSEGateway® connection method to the <i>MQTT Broker</i> is via <i>Ethernet</i> .
Clean Session on Connect	<i>Clean Session on Connect</i> tells the MQTT Broker whether the DSEGateway® wants to establish a persistent session or not. <input checked="" type="checkbox"/> = The MQTT Broker does not store anything for the DSEGateway® and purges all information from any previous persistent session. <input type="checkbox"/> = the MQTT Broker stores all subscriptions for the DSEGateway® and all missed messages for the DSEGateway® that subscribed with a Quality of Service (QoS) of level 1 or 2.
MQTT Keep Alive	Entered in seconds. Periodically the DSEGateway® sends <i>Keep Alive</i> message to the MQTT Broker to maintain the connection. If the MQTT Broker does not receive any <i>Keep Alive Messages</i> for the configured <i>MQTT Keep Alive</i> period, the connection will be closed. The DSEGateway® also looks for <i>Keep Alive</i> message from the MQTT Broker. If the DSEGateway® does not receive any <i>Keep Alive Messages</i> from the MQTT Broker for the configured 4x the <i>MQTT Keep Alive</i> period, it will attempt to recover the connection.

Parameter descriptions continued overleaf...

Parameter	Description
Group Name	A name that can be used in MQTT Topics, as a reference for the type of devices attached to specific DSEGateway®. For example, if all devices connected the DSEGateway® are DSE modules, a <i>Group Name</i> of DSE could be used.
Client Name	The name of the DSEGateway® as seen by the MQTT Broker. Some MQTT Brokers require this to be unique as it is used to maintain the session when <i>Clean Session on Connect</i> is disabled. An example unique <i>Client Name</i> would be the <i>Gateway USBID</i> .
Username	<p> <b>NOTE: Only applicable by Use Login Credentials is enabled.</b></p> <p>Enter the username the MQTT Broker requires when an MQTT Client is establishing a connection.</p>
Password	<p> <b>NOTE: Only applicable by Use Login Credentials is enabled.</b></p> <p>Enter the password the MQTT Broker requires when an MQTT Client is establishing a connection.</p>
Use Login Credentials	<p> <b>NOTE: When enabled a Username and Password MUST be configured.</b></p> <p><input checked="" type="checkbox"/> = The MQTT Broker requires MQTT Clients to use login credentials. The DSEGateway® uses the <i>Username</i> and <i>Password</i> to establish a connection to the MQTT Broker.</p> <p><input type="checkbox"/> = The MQTT Broker does not require MQTT Clients to use login credentials.</p>
Use Secure MQTT	<p> <b>NOTE: When enabled for use on a public network, a password and/or client certificate should be used.</b></p> <p><input checked="" type="checkbox"/> = Enables TLS 1.2 encryption for all MQTT traffic from the DSEGateway®</p> <p><input type="checkbox"/> = The MQTT traffic from the DSEGateway® is not encrypted.</p>
Use Client Certificate	<p>The Client Certificate is used verifies to the MQTT Broker that the DSEGateway® is legitimate device and not a malicious attack.</p> <p><input checked="" type="checkbox"/> = The MQTT Broker verifies the <i>Client Certificate</i> uploaded to the DSEGateway® against the <i>Certification Authority (CA) Certificates</i> it holds. Typically, <i>Client Certificates</i> expire every 6 to 12 months and thus must be renewed at regular intervals. The <i>Client Certificate</i> uploaded to the DSEGateway® is renewed either by the web configuration pages or MQTT commands.</p> <p><input type="checkbox"/> = The MQTT Broker does not verify the <i>Client Certificate</i> uploaded to the DSEGateway®.</p>

Parameter descriptions continued overleaf...

Parameter	Description
Client Certificate	<p><b>▲ NOTE: Client certificates contain 2 parts, which are a key and a client certificate. If these are separate files, they MUST be combined into a single certificate. The file type MUST be .crt or .pem and MUST be base64 encoded. The name of the file MUST be 48 characters or less.</b></p> <p><b>▲ NOTE: For further assistance contact Deep Sea Electronics Technical Support; support@deepseaelectronics.com</b></p> <p>Option to upload The <i>Client Certificate</i> to the DSEGateway® which the MQTT Broker uses to verify against the Certification Authority Certificates it holds. Typically expire every 6 to 12 months.</p>
CA Certificate	<p><b>▲ NOTE: The file type MUST be .crt or .pem and MUST be base64 encoded. The name of the file MUST be 48 characters or less.</b></p> <p><b>▲ NOTE: For further assistance contact Deep Sea Electronics Technical Support; support@deepseaelectronics.com</b></p> <p>Option to upload the <i>CA (Certification Authority) Certificate Server</i> used by the DSEGateway® to verify the MQTT Broker is who is expected and avoid man in the middle attacks. Typically expire every 2 to 10 years.</p>

### 5.3.5 GSM

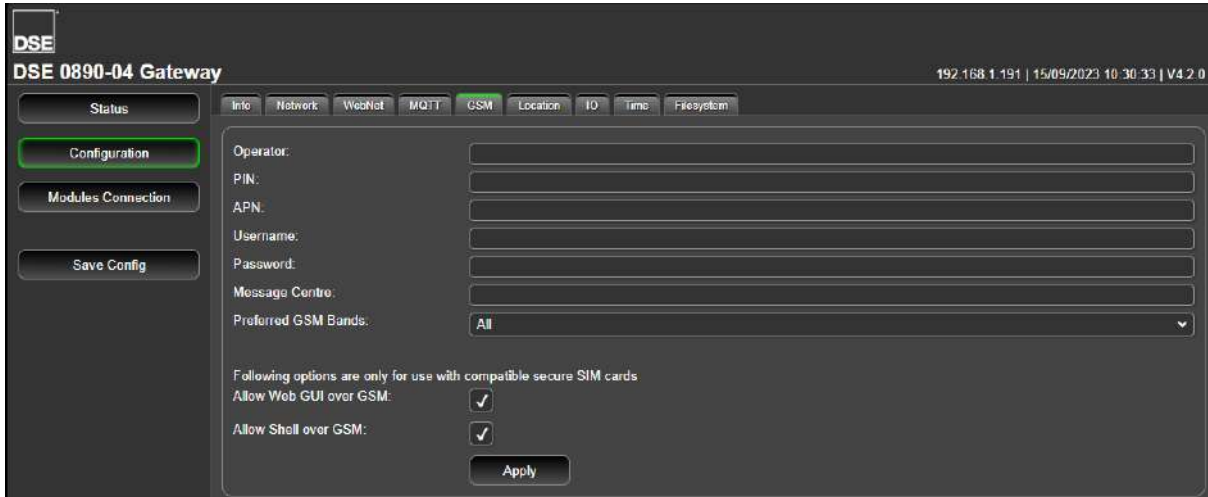

**NOTE: GSM settings are obtainable by contacting the SIM provider. These are obtainable by contacting the phone network provider or checking the SIM packaging.**

Configure the DSEGateway® to suit the phone network requirements.



Parameter	Description
Operator	Name of the GSM network operator. If the box is left empty, the DSEGateway® connects to the first available network the SIM card sees as available. Therefore in most cases it is beneficial to leave this box empty.  However if a specific GSM network operator connection is required (e.g. for low cost tariffs), enter the exact name as provided by the SIM card supplier.
PIN	<p><b>NOTE: When using the SIM card from a mobile phone, this is the PIN code of the SIM card, NOT the PIN code of the mobile phone!</b></p>
	PIN of the SIM card (where used).
APN	GSM Access Point Name, provided by the SIM card supplier.
Username Password	GSM login details, provided by the SIM card supplier.
Message Centre	SMS message centre number, provided by the SIM card provider.
GSM Bands	Select the GSM Band used for the internet connection. This forces the DSEGateway® to only connect on the desired GSM connection. This is used to ensure that best GSM band is used for the fastest connection speed available. <b>All:</b> The DSEGateway® connects to either the 2G, 3G or 4G connection. <b>2G + 4G:</b> The DSEGateway® only connects to internet via a 2G or 4G connection. <b>3G + 4G:</b> The DSEGateway® only connects to internet via a 3G or 4G connection. <b>4G:</b> The DSEGateway® only connects to internet via a 4G connection. <b>3G:</b> The DSEGateway® only connects to internet via a 3G connection. <b>2G + 3G:</b> The DSEGateway® only connects to internet via a 2G or 3G connection. <b>2G:</b> The DSEGateway® only connects to internet via a 2G connection.

Parameter descriptions continued overleaf...

Parameter	Description
Allow Web GUI over GSM	<p> <b>NOTE: Only to be enabled when used with a compatible secure SIM card.</b></p> <p><input type="checkbox"/> = The Web GUI cannot be accessed over GSM  <input checked="" type="checkbox"/> = The Web GUI can be accessed over GSM</p>
Allow Shell over GSM	<p> <b>NOTE: Only to be enabled when used with a compatible secure SIM card.</b></p> <p> <b>NOTE: Only to be used under instruction of DSE Technical support</b></p> <p><input type="checkbox"/> = The Debug Shell cannot be accessed over GSM  <input checked="" type="checkbox"/> = The Debug Shell can be accessed over GSM</p>

**SMS Test**

For testing purposes it is possible to send an SMS from the DSEGateway® using the Send SMS feature.



Parameter	Description
Phone Number	<p> <b>NOTE: The phone number entered must be prefixed with the correct country code, for example a UK phone number of 07700 900900 would be +44 7700 900900 (UK area code).</b></p> <p>Enter the Phone Number which the SMS message is to be sent to.</p>
Message	Enter the SMS message to be sent to the <i>Phone Number</i> for testing purposes.

### 5.3.6 LOCATION

This is the location of the DSEGateway® and is not the location of the connected DSE modules, this is configured elsewhere. For further details, see section entitled *Modules Connection* elsewhere in this document.

This location is used by the DSEWebNet® when placing the DSEGateway® Icon onto the world map as shown below.

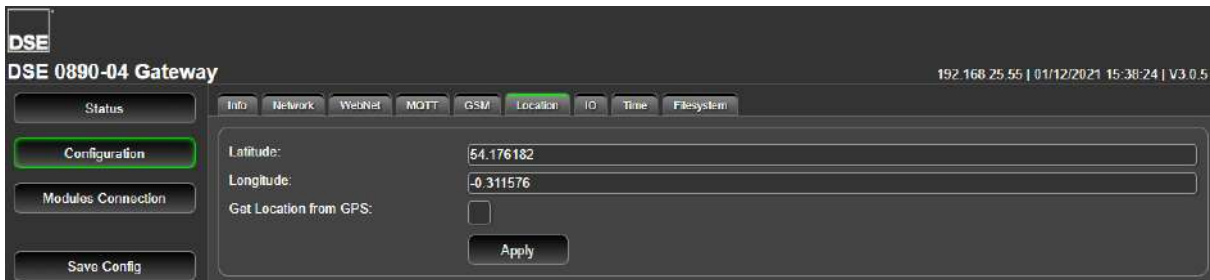

Parameter	Description
Latitude Longitude	<p><b>NOTE: Latitude and Longitude must be entered as decimal values (not degrees, minutes, seconds).</b></p> <p>Manually entered location of the DSEGateway®.</p> <p>Locations <b>East</b> of the Greenwich Meridian = <b>positive</b>                      Locations <b>West</b> of the Greenwich Meridian = <b>negative</b>                      Locations <b>North</b> of the Equator = <b>positive</b>                      Locations <b>South</b> of the Equator = <b>negative</b></p> <p><b>For example:</b>                      54.18° N, 0.31° W is entered as</p> <p>Latitude: 54.18                      Longitude: -0.31</p>
Get Location From GPS	<p><input checked="" type="checkbox"/> = GPS is used to determine the site location for positioning the site on the World map in the DSEWebNet® server. Additionally, this location is used for the Geofence function, to alert users when the DSEGateway® moves outside the configured Geofence.</p> <p>If no GPS signal is located, the manually entered location is used.</p> <p><input type="checkbox"/> = Location is manually entered.</p>

### 5.3.7 IO

Allows configuration of the DSEGateway® I/O (Inputs/Outputs) The DSEWebNet® system is used to activate/deactivate the Outputs and show the status of the inputs.

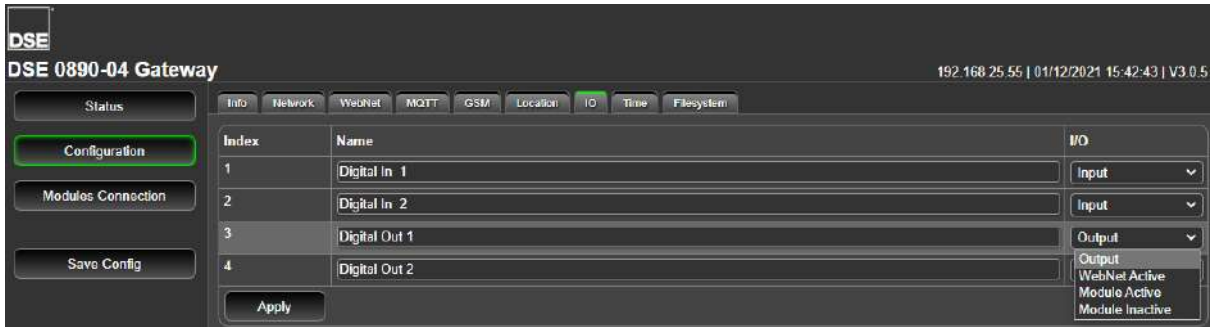

Index	Description
Name	Enter the name to identify the I/O channel on the DSEWebNet® system.
1	Terminals 6 and 7 are digital inputs and are configured as:
2	<b>Input:</b> Connect the digital input to the digital input ground terminal to activate.
3	Terminals 3 and 4 are Outputs and are configured as
4	<b>Output:</b> Active when manually driven by the DSEWebNet® or MQTT Command. <b>WebNet Active:</b> Activates when the connection to the DSEWebNet® Realtime Server is active <b>Module Active:</b> Activates when the connection to the associated Module is active <b>Module Inactive:</b> Activates when the connection to the associated Module is inactive

### 5.3.8 TIME

**NOTE:** The *Time* shown on the DSEGateway® is automatically synchronised with the time of the DSEWebNet® upon connection if a connection to the DSEWebNet® server is enabled.

Before being transmitted to the DSEWebNet® servers, all DSE Module events are allocated a *Timestamp* by the DSEGateway®. This *Timestamp* varies depending on how the DSEGateway® is configured.

Below is an example of the *Timestamp* shown on DSEWebNet®...

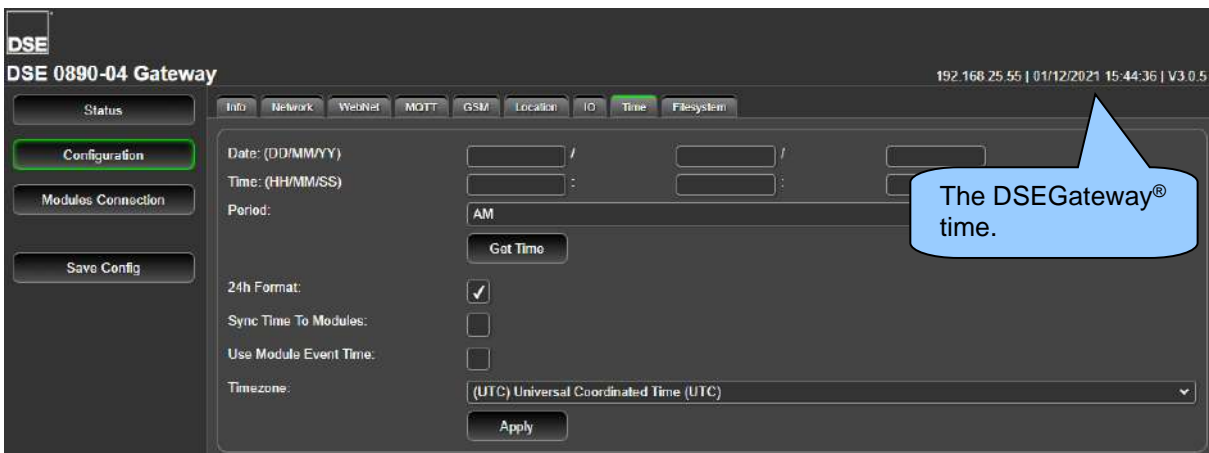

Parameter	Description
Date:	<p><b>NOTE:</b> This option is only available when <i>Connection Method</i> for the <i>WebNet</i> is set to <i>None</i>. When <i>Connection Method</i> for the <i>WebNet</i> is enabled, the <i>Date</i> is synchronised with the <i>DSEWebNet</i> server.</p> <p>Set the date within the DSEGateway®.</p>
Time:	<p><b>NOTE:</b> This option is only available when <i>Connection Method</i> for the <i>WebNet</i> is set to <i>None</i>. When <i>Connection Method</i> for the <i>WebNet</i> is enabled, the <i>Time</i> is synchronised with the <i>DSEWebNet</i> server.</p> <p>Set the time within the DSEGateway®.</p>
Period:	<p><b>NOTE:</b> This option is only available when <i>Connection Method</i> for the <i>WebNet</i> is set to <i>None</i>.</p> <p>Set the time period between <i>AM</i> and <i>PM</i> used within the DSEGateway®.</p>
Get Time	<p><b>NOTE:</b> This option is only available when <i>Connection Method</i> for the <i>WebNet</i> is set to <i>None</i>.</p> <p>Gets the <i>Date</i>, <i>Time</i> and <i>Period</i> from the PC and configures them within the DSEGateway®.</p>

Parameter descriptions continued overleaf...

Parameter	Description
24h Format	<input type="checkbox"/> = The Time Format is displayed on the DSEGateway® in 12h format. <input checked="" type="checkbox"/> = The Time Format is displayed on DSEGateway® in 24h format.
Sync Time to Modules	<input type="checkbox"/> = The connected Modules are not synchronised with the DSEGateway® clock <input checked="" type="checkbox"/> = The connected Modules are synchronised with the DSEGateway® clock. This ensures all Modules and the DSEGateway® display the same time.
Use Module Event Time	<input type="checkbox"/> = The time displayed on DSEWebNet® relates to the time at which the DSEGateway® read the event from the Module. <input checked="" type="checkbox"/> = The time displayed on DSEWebNet® relates to the time at which the Event took place according to the Modules event log.
Time Zone	The Time Zone that is displayed on the DSEGateway® web browser. This has no effect on the <i>Timestamp</i> shown on DSEWebnet®.

### 5.3.9 FILE SYSTEM

The *File System* menu allows for management of the DSEGateway® *Internal File System*. The *Internal File System* stores the DSEGateway® firmware, DSE Module description file and DSEGateway® configuration file.

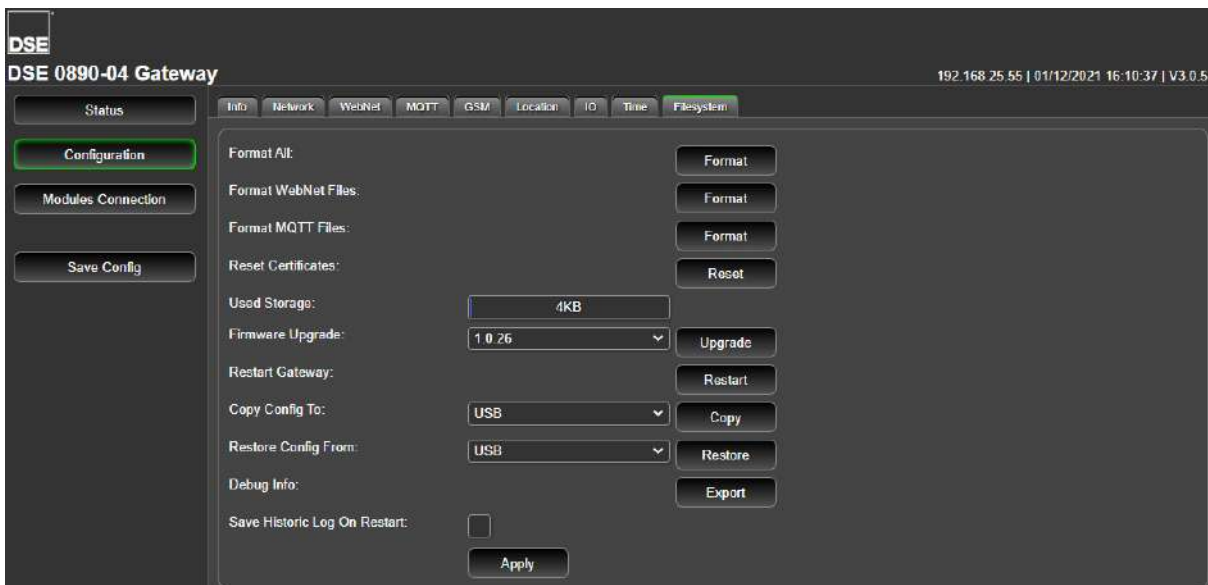

Parameter	Description
Format All	<p>The DSEGateway® File System contains templates instructing the DSEGateway® how to communicate with connected DSE Modules for DSEWebNet, Topic files for MQTT and certificates for MQTT communication. . Initially, this file system is empty.</p> <p>Using the <i>Format All</i> option deletes all the DSEWebNet template files, Topic files and MQTT certificates. It does not affect any of the other configuration settings within the DSEGateway®.</p>
Format WebNet Files	<p>Occasionally it is desired to erase any stored DSEWebNet templates from the DSEGateway®, which forces the download of new templates when required from the DSEWebNet server. This is performed if updates are made to the templates and DSE Technical Support advise this to be done.</p> <p>Using the <i>Format WebNet Files</i> option deletes all the DSEWebNet template files only.</p>
Format MQTT Files	Using the <i>Format MQTT Files</i> option deletes all the MQTT Topic files only.
Reset Certificates	Using the <i>Reset Certificates</i> option deletes all the MQTT Certificates only.

Parameter descriptions continued overleaf...

Parameter	Description
Used Storage	Indicates the amount of data used from the DSEGateway® internal memory to store the DSEWebNet template files, MQTT Topic Files, MQTT Certificates and stored DSEGateway® configuration files.
Firmware Upgrade	Allows “Over The Air” (OTA) updates to the firmware of the DSEGateway®. Select the required version and click <i>Upgrade</i> . This requires an active connection to the DSEWebNet® service ideally over Ethernet.
Restart Gateway	Reboots the DSEGateway®. This is necessary after a Firmware Upgrade.
Copy Config	<p><b>▲ NOTE: Only one Configuration file is stored on the DSEGateway® Internal File Memory System.</b></p> <p>Copy's the DSEGateway® configuration file to either:  <b>USB:</b> A USB memory device inserted into the DSEGateway®'s USB port.  <b>Filesystem:</b> The DSEGateway®'s internal memory.</p>
Restore Config from	<p><b>▲ NOTE: When restoring the Configuration File, it must be named as BACKUP.BIN</b></p> <p>Restores the DSEGateway® configuration either:  <b>USB:</b> A USB memory device inserted into the DSEGateway®'s USB port.  <b>Filesystem:</b> The DSEGateway®'s internal memory.</p>
Debug Info	<p><b>▲ NOTE: Only to be used under instruction of DSE Technical support</b></p> <p>Exports Debug information to a location on the PC.</p>
Save Historic Log On Restart	<p><b>▲ NOTE: For more information regarding the Historic server connection see section entitled Modules Connection described elsewhere in this manual.</b></p> <p><input type="checkbox"/> = During a controlled restart, the DSEGateway® does not save any buffered historic information.  <input checked="" type="checkbox"/> = During a controlled restart, the DSEGateway® saves any buffered historic data. Upon restart and subsequent re-connection to the DSEWebNet® servers, the DSEGateway® attempts to re-transmit any buffered historic data.</p>

## 5.4 MODULES CONNECTION (ADDING AND REMOVING MODULES)

### 5.4.1 MODULES

**NOTE:** The DSEGateway® supports a maximum of 5 DSE Modules.

**NOTE:** The *Module Connection* port is used for DSEWebNet, MQTT and *Modbus Passthrough*. Whilst the *Module Passthrough* port is open, traffic to DSEWebNet® and the MQTT Broker becomes intermittent. Once the port closes the traffic resumes.

**NOTE:** Any disconnected communication Ports must be deleted from the *Modules Connection* configuration.

To ensure newly added Modules are recognised by the DSEGateway®, the following steps must be followed.

The DSEGateway® is factory set to accept connection via the USB port for DSEWebNet® communication. If this does not match the communication requirements, the entry must be deleted in the *Module Connections | Modules* page of the DSEGateway®, and/or the Module being enabled for DSEWebNet/MQTT. It must then be re-configured to suit the communication type required (RS485 or Ethernet). The process below explains how this can be achieved.

1. Connect to the DSEGateway® configuration page as described in the *Quick Set-up Guide* section of this document.
2. Select *Modules Connection* and configure each port to match the controller being connected.
3. Click *Apply* then *Save config*. The DSEGateway® then automatically reboots.
4. Check the *Modules Connection* page to ensure the settings have taken effect.

**1. Clicking Apply confirms the Connection settings...**

**2. Clicking Save Config saves settings and restarts the DSEGateway...**

Modbus Client				Location			Controller	
Index	Type	ID / IP	Port	Use GPS	Latitude	Longitude	PIN	USB ID
1	USB	-	-	Yes	-	-	-	6F1E5F7B85
Add:	RS485	Modbus ID		<input type="checkbox"/>	54.176182	-0.311576		

**Communication Speed**

Configure the speed of the communication ports between the DSEGateway® and the device.

J1939 Bit Rate:	250 Kbps	<input type="button" value="Apply"/>
RS485 Baud Rate:	115200	

Parameter	Description
J1939 Bit Rate	<p><b>▲ NOTE: This option is only applicable when the MQTT connection is used and the <i>Topic File</i> has been configured to use the CAN connection.</b></p> <p>Select the bit rate of the CAN connection used for J1939 communication to the third party CAN device.</p>
RS485 Baud Rate	Select the baud rate of the RS485 connection used to communicate to the DSE Module for DSEWebNet and MQTT communication.

**Modbus Client**

Configure the communication protocol between the DSEGateway® and the DSE Module

Modbus Client			
Index	Type	ID / IP	Port
1 <input checked="" type="radio"/>	USB	-	-
2 <input type="radio"/>	RS485	10	-
3 <input type="radio"/>	Ethernet	192.168.1.100	502
Add:	RS485	Modbus ID...	

Parameter	Description
Index	Shows the status of connection between the DSEGateway® and the DSE Module <input checked="" type="radio"/> = The connection to the DSE module is established <input type="radio"/> = The connection to the DSE module is not established, check configuration and installation for errors.
Type	This is the port that is used by the DSEGateway® to connect to the DSE Module <b>RS485:</b> Connection to one or more RS485 enabled Modules using suitable RS485 connection cable. <b>Ethernet:</b> Connection to an Ethernet network of one or more Modules. <b>USB:</b> Single connection to a supported DSE Module by USB A to USB B cable.
ID / IP	When <i>Type</i> is configured to <i>Ethernet</i> – IP address of the connected Module When <i>Type</i> is configure to <i>RS485</i> – Modbus server address of the selected Module. Where multiple devices are connected (RS485), a unique ID must be used for each Module.
Port	When <i>Type</i> is configured for <i>Ethernet</i> , configure the TCP port to be used for Modbus (usually 502).

Parameters shown overleaf...

**Location**

Location		
Use GPS	Latitude	Longitude
Yes	-	-
No	54.176182	-0.311576
Yes	-	-
<input checked="" type="checkbox"/>	<input type="text"/>	<input type="text"/>

Parameter	Description
Use GPS	<p>This is the location of the DSE module and is not the location of the connected DSEGateway®, this is configured elsewhere. For further details, see section entitled <i>Configuration</i> elsewhere in this document .</p> <p>This location is used by the DSEWebNet® when placing the DSE module's con onto the world map as shown below.</p>  <p><input type="checkbox"/> = Location of the DSE module is entered manually. Where multiple Modules are connected to the DSEGateway®, it may be more appropriate to enter the location of each device manually. This allows each Module to show on the map at its specific location instead of showing all Modules at the same location as the DSEGateway®</p> <p><input checked="" type="checkbox"/> = GPS location is transmitted to the DSEWebNet® Server. The value depends on the DSEGateway® Configuration (fixed or use location). This is used for live tracking and the <i>Geofence</i> feature of the DSEWebNet® system.</p>
Latitude Longitude	<p>Manually entered location of the selected Module. This is useful in cases where the Module is located some distance from the Gateway. For example the generator house may be at one side of a site, with the DSEGateway® located in the IT department. Manually entering the location of the generator house shows this location on the DSEWebNet® map, rather than the location of the IT department.</p> <p>Manually entered location (in degrees) of the DSE Module.</p> <p>Locations <b>East</b> of the Greenwich Meridian = <b>positive</b> Locations <b>West</b> of the Greenwich Meridian = <b>negative</b> Locations <b>North</b> of the Equator = <b>positive</b> Locations <b>South</b> of the Equator = <b>negative</b></p> <p><b>For example</b> 54.18° N, 0.31° W is entered as</p> <p>Latitude: 54.18 Longitude: -0.31</p>

Parameters shown overleaf...

**Controller**

Controller		
PIN	USB ID	
	6926D825AF	Delete
	6D825AF692	Delete
	D8269265AF	Delete
<input type="text"/>		Apply

Parameter	Description
PIN	Enter the 4-digit PIN that is configured within the DSE module. If the DSE module does not have a PIN configured, leave the parameter empty.
USB ID	This is the unique USB ID number for the connected DSE module. This is automatically read from the DSE Module.

### 5.4.2 DSEWEBNET

**DSE 0890-04 Gateway** 192.168.1.191 | 14/09/2023 14:55:34 | V4.2.0

Modules: DSE WebNet | MQTT | Modbus

NOTE: Increasing/disabling the Upload interval could have an adverse effect on the DSEWebNet performance. Consult the DSE890/DSE891 MKII Gateway Operators Manual before making changes.

Historic Upload Interval: 10 min

Modbus Client				Location			Controller		
Index	Type	ID / IP	Port	Use GPS	Latitude	Longitude	PIN	USB ID	Enabled
1	USB	-	-	Yes	-	-	-	6F1E5F7B85	<input checked="" type="checkbox"/>

Apply

#### Historic Upload Interval

**NOTE:** On DSEGateway®s with V2.x.x firmware the Data Resolution between the DSEGateway® and the DSE Module is configured on DSEWebNet®. For further details refer to DSE Publication: 057-168 DSEWebNet PC Internet Browser Software Manual.

The DSEGateway® periodically collects data from its connected modules and stores it within its own memory buffer. Upon a module event occurring (such as Generator Start/Stop, Mains fail etc) this buffered data is immediately uploaded to the DSEWebnet® historic servers. The historic servers allow Module data to be stored and displayed on DSEWebNet® for up to 1 month. This Historic Data is utilised when creating reports and activating relevant triggers.

During any prolonged period of inactivity the DSEGateway® periodically uploads any data that has been buffered, this periodic upload interval is configured within the DSEGateway®. This is known as the *Historic Upload Interval*.

NOTE: Increasing/disabling the Upload interval could have an adverse effect on the DSEWebNet performance. Consult the DSE890/DSE891 MKII Gateway Operators Manual before making changes.



Historic Upload Interval: 10 min

Parameter	Description
Historic Upload Interval	<p>Determines the period at which the DSEGateway® uploads its Historic data to the DSEWebNet® server.</p> <p>Shorter upload intervals increase the number of connections to the DSEWebNet® Server and may increase data costs depending upon the service contract with the internet provider.</p> <p>Disabling the Historic Upload Interval will have an adverse effect on DSEWebNet® historic Data.</p>

Parameters continued overleaf...

**DSEWebNet Connection**

Index	Modbus Client			Location			Controller		Enabled
	Type	ID / IP	Port	Use GPS	Latitude	Longitude	PIN	USB ID	
1 	USB	-	-	Yes	-	-		6F1E5F7B85	<input checked="" type="checkbox"/>

Parameter	Description
Index	Shows the status of connection between the DSEGateway® and the DSE Module for use with the DSEWebNet.  = The connection to the DSE module is established and connection to the DSEWebNet has been enabled.  = The connection to the DSE module is established but the connection to the DSEWebNet has not been enabled.  = The connection to the DSE module is not established, check <i>Module Connections / Modules</i> configuration section and the installation for errors.
Enable	<input type="checkbox"/> = The DSEGateway® does not communicate with the DSEWebNet server for that specific DSE module. <input checked="" type="checkbox"/> = The DSEGateway® does communicate with the DSEWebNet server for that specific DSE module.

### 5.4.3 MQTT

		Modbus Client		Location			Controller		
Index	Type	ID / IP	Port	Use GPS	Latitude	Longitude	PIN	USB ID	Enabled
1	USB	-	-	Yes	-	-		6F1E5F7B85	<input checked="" type="checkbox"/>





#### MQTT Topic Files

Parameter	Description
Device	<b>Gateway:</b> Select when the DSEGateway® needs to have its MQTT Topic information amended. <b>Module Index 1 to 5:</b> Select the appropriate <i>Module Index</i> that needs to have its MQTT Topic information amended.
Topic File	<p><b>NOTE:</b> For further information on how to create <i>MQTT Topic Files</i>, refer to section entitled <i>Topic File</i> elsewhere in this document.</p> <p><b>NOTE:</b> The filename for the <i>MQTT Topic Files</i> must be less than 48 characters including the .csv extension.</p> <p><b>Upload:</b> Upload an MQTT Topic File from the PC to the DSEGateway® for the selected <i>Device</i>.  <b>Download:</b> Download the MQTT Topic File from the DSEGateway® to the PC for the selected <i>Device</i>.  <b>Remove:</b> Delete the MQTT Topic File from the DSEGateway® for the selected <i>Device</i>.</p>
Est. Data Usage	The total estimated MQTT Published data usage per month for all the configured topics for all the connected devices. MQTT Subscribed data is not included in this estimation.
File Status:	Shows the status / errors for the MQTT Topic files uploaded to the DSEGateway®.

**MQTT Connection**

Index	Modbus Client			Location			Controller		Enabled
	Type	ID / IP	Port	Use GPS	Latitude	Longitude	PIN	USB ID	
1 	USB	-	-	Yes	-	-		6F1E5F7B85	<input checked="" type="checkbox"/>

Apply

Parameter	Description
Index	Shows the status of connection between the DSEGateway® and the DSE Module for use with the MQTT Broker.  = The connection to the DSE module is established and connection to the MQTT Broker has been enabled.  = The connection to the DSE module is established, connection to the MQTT Broker has been enabled but there is no <i>Topic</i> file loaded for that connection.  = The connection to the DSE module is established but the connection to the MQTT Broker has not been enabled.  = The connection to the DSE module is not established, check <i>Module Connections / Modules</i> configuration section and the installation for errors.
Enable	<input type="checkbox"/> = The DSEGateway® does not communicate with the MQTT Broker for that specific DSE module. <input checked="" type="checkbox"/> = The DSEGateway® communicates with the MQTT Broker using the specific Topic File for that DSE module.

### 5.4.4 MODBUS

**NOTE:** This section is only used when setting up the DSEGateway® to operate as a communications protocol convertor.

**NOTE:** The DSEGateway® supports a maximum of 5 DSE Modules.

**NOTE:** The *Module Connection* port is used for DSEWebNet, MQTT and *Modbus Passthrough*. Whilst the *Module Passthrough* port is open, traffic to DSEWebNet® and the MQTT Broker becomes intermittent. Once the port closes the traffic resumes.

**NOTE:** DSE recommend the use of fixed IP address when configuring a connection via an Internet connection. Failure to connect via a fixed IP address could result in the IP address changing according to network requirements and without prior notification. Contact your network or SIM card provider for more details.

This page is used to configure the DSEGateway® as a Modbus Gateway to allow conversion across the various ports.

It can be used for example to set *USB* as a Modbus client to connect to any DSE Module fitted with a USB port and supporting the DSE Configuration Suite SCADA function.

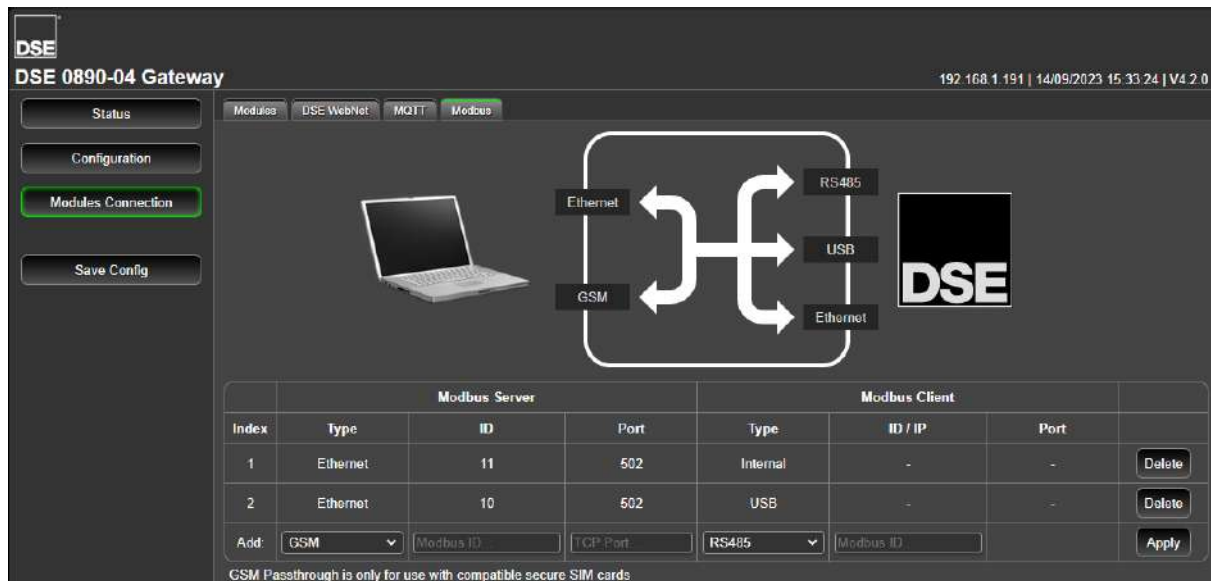

#### Modbus Server

These are the settings of the DSEGateway® port that is connected to the monitoring device.

Parameter	Description
Type	This is the Modbus server port that is connected to the Modbus client (for example PC, Building Management System or PLC). <b>GSM:</b> Connection to the Modbus client via GSM. <b>Ethernet:</b> Connection to an Ethernet network accessible by the Modbus client.
ID	Modbus server address of the selected DSEGateway® port.
Port	When <i>Type</i> is configured for <i>Ethernet</i> , configure the TCP port to be used for Modbus (usually 502).

**Modbus Client**

These are the settings of the DSEGateway® port that is used to connect to the DSE Module.

Parameter	Description
Type	This is the port that is connected to the DSE Module. <b>RS485:</b> Connection to one or more RS485 enabled Modules using suitable RS485 connection cable. <b>Ethernet:</b> Connection to an Ethernet network of one or more Modules. <b>USB:</b> Single connection to a supported DSE Module by USB A to USB B cable.
ID / IP	Modbus Server address of the connected DSE Module. When <i>Type</i> is configured for <i>RS485</i> , configure the Modbus Server ID of the DSE module. When <i>Type</i> is configured for <i>Ethernet</i> , configure the IP address of the DSE module.
Port	When <i>Type</i> is configured for <i>Ethernet</i> , configure the TCP port to be used for Modbus (usually 502).

**Modbus Server:** The port connected to the

**Modbus Client:** The port connected to the DSE

Index	Modbus Server			Modbus Client			Delete
	Type	ID	Port	Type	ID / IP	Port	
1	Ethernet	11	502	Internal	-	-	Delete
Add:	Ethernet	Modbus ID...	TCP Port...	RS485	Modbus ID...		Apply

GSM Passthrough is only for use with compatible secure SIM cards

Index 1 is receiving Modbus requests from the external monitoring system on **Ethernet, Port 502**. This is being transferred to the DSE Module via the **RS485** port using **Modbus Server ID 10** on the DSEGateway®

### 5.4.4.1 EXAMPLE OF MODBUS PASSTHROUGH VIA ETHERNET OR GSM

Below is a typical example of a Modbus passthrough allowing DSE Configuration Suite to Read and Write DSE Configuration files to the Module.

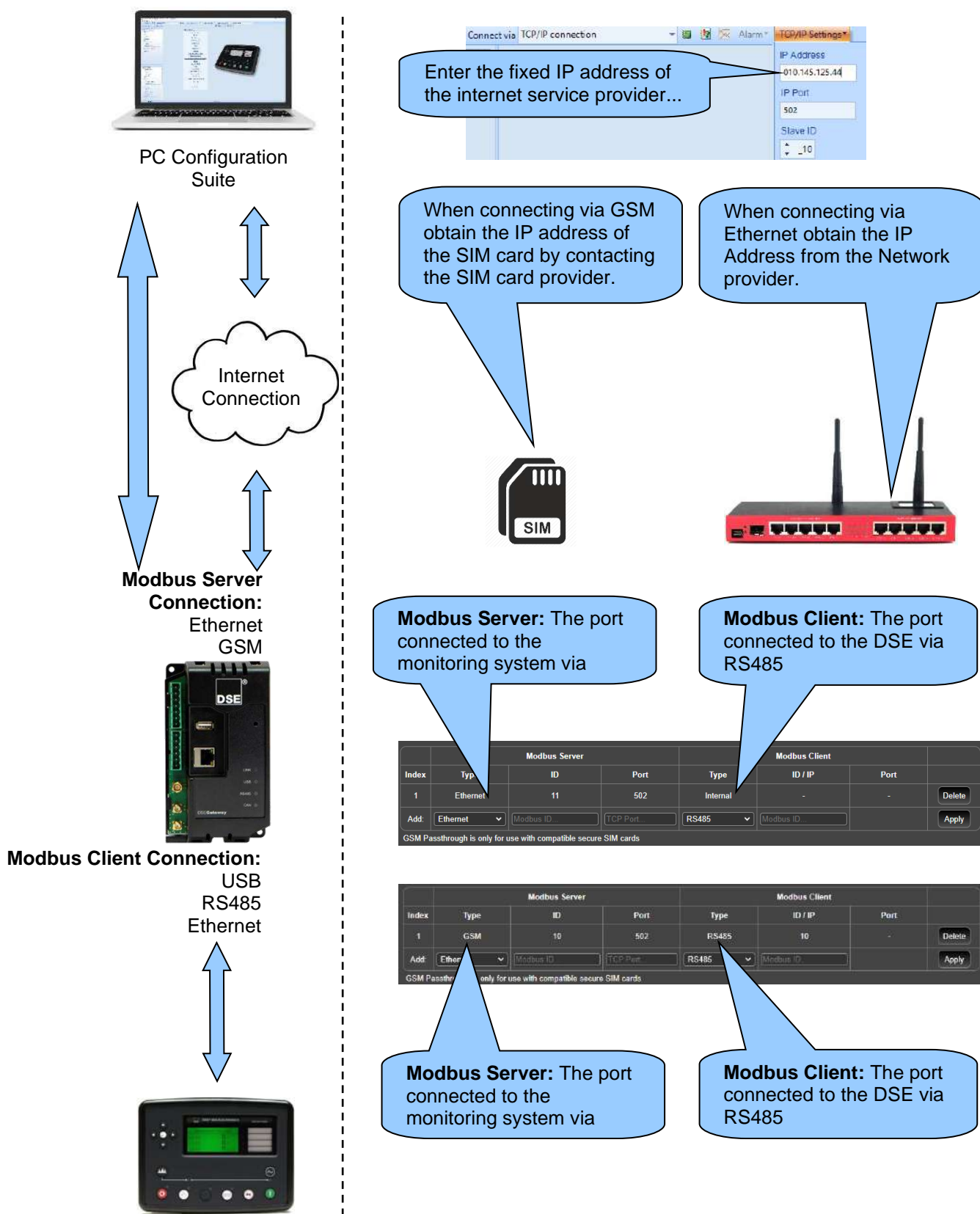

## 6 MQTT

The DSEGateway supports MQTT v3.1.1 (ISO/IEC 20922:2016). This enables connection to a third-party server running an MQTT Broker, whilst simultaneously supporting connection to the DSEWebNet Server.

The third-party MQTT Broker may be located on a local network, or on a Cloud based Servers (e.g. AWS, google, IBM Watson, Microsoft Azure). Secure MQTT passthrough using an MQTT Broker allows a secure and customisable remote configuration and SCADA connection to DSE Modules over Ethernet, or Cellular Networks.

The DSEGateway supports fully configurable *Topic* names for both Publish and Subscribe feeds and all data is sent using standard JSON Notation. The available data and functions available through Publish and Subscribe feeds are as follows.

Data available to Publish to MQTT Broker:

- Data from DSE Module Gencomm Register
- DSE Module Alarms and Events
- DSEGateway Inputs (digital or resistive format)
- DSEGateway GPS Data
- J1939 CAN data from third party CAN device
- J1939 DM1 diagnostic codes from third party CAN device

Functionality available by Subscription to MQTT Broker:

- Full control of DSE Modules
- Writing to DSE Module Gencomm registers
- Full control of Gateway Outputs
- Remote Connection Details and MQTT configuration updates
- Remote Certificate updates

### 6.1 TOPICS

A Topic in MQTT is a data object that is published to an MQTT Broker from an MQTT Client. The MQTT Broker then publishes the MQTT Topics to subscribed MQTT Clients. The MQTT Topic contains a single or list of parameters/instruments, depending upon how the *Topic File* is configured.

Within the *Topic File*, each MQTT Topic must be mapped to one of the following functions:

1. DSE Module Instrumentation (Modbus Register) Publish and Subscribe
2. DSE Configuration Read/Write request with DSE Configuration Suite
3. DSE Module Control Commands
4. DSE Module Alarms
5. DSE Module Events
6. J1939 (CAN) Data
7. DSEGateway X.509 Certificate Update
8. DSEGateway X.509 Certificate Status
9. DSEGateway Topic File update
10. DSEGateway GPS Location
11. Fixed Data
12. Connection Details Update
13. J1939 (CAN) DTC

MQTT Topics are published to the MQTT Broker at a configured update period, as set within the *Topic File*. The DSE Gateway attempts to maintain this period but it may be restricted due to bandwidth limitations or the size of the *Topic File*.

## 6.2 TOPIC FILE

**NOTE:** For further information on how to upload the *MQTT Topic Files* to the DSE Gateway, refer to section entitled *Modules Connection (Adding And Removing Modules)* elsewhere in this document.

**NOTE:** The *MQTT Topic Files* must be saved in a .csv format and their filename must be less than 48 characters, including the .csv extension.

The *Topic File* configures what MQTT functions the DSE Gateway uses for each of the devices connected. Each device connected to the DSE Gateway must have its own *Topic File* associated with it. The *Topic File* must be in a .csv file format and have its contents/data formatted in a specific way. The subsequent sections of this manual explain in detail how the *Topic File* must be formatted.

The first row of the *Topic File* is ignored by the DSE Gateway and is intended to be used as column headings. If column headings are not used within the *Topic File*, then the data must be entered starting at the second row. The order of the columns must follow the below format:

Topic	Topic Mask	Type	Properties	Period	QOS	Expiry	Flags	Function	Field 1	Field 2	...Field 9	Notes
-------	------------	------	------------	--------	-----	--------	-------	----------	---------	---------	------------	-------

Any column after *Notes* which contains data is ignored by the DSE Gateway. The *Notes* column may contain descriptions for each of the *MQTT Topics* entered into each row. A complete example of a *Topic File* for a DSE Genset Module is shown below.

Topic	Topic Mask	Type	Properties	Period	QOS	Expiry	Flags	Function	Field 1	Field 2	Field 3	Field 4	Field 5	Field 6	Field 7	Field 8	Field 9	Notes
%GROUP%/TYPE%/UID%/Mains_L-N		P		15	0			1	4	36	2	2	0					
%GROUP%/TYPE%/UID%/Mains_L-N		P		15	0			1	4	38	2	2	0					
%GROUP%/TYPE%/UID%/Mains_L-N		P		15	0			1	4	40	2	2	0					
%GROUP%/TYPE%/UID%/Gen_L-N_All		P		15	0		R	1	4	8	6							
%GROUP%/TYPE%/UID%/Alarms		P		0	2			4										
%GROUP%/TYPE%/UID%/Events		P		0	2			5										
%GROUP%/TYPE%/UID%/GPS		P		60	1		R	10										
%GROUP%/TYPE%/UID%/Button		S		0	0			3										
%GROUP%/TYPE%/UID%/Page/%F1%/Reg/%F2%		P		30	0			1	0	1	1							
%GROUP%/TYPE%/UID%/Page/%F1%/Reg/%F2%		P		30	0			1	0	2	1							
%UID%/Modbus_Response		P		0	1			2										
%UID%/Modbus_Request		S		0	1			2										
%UID%/this_topic_file		S		0	0			9										
%GROUP%/TYPE%/UID%/PLC/1		S		0	1		D	1	70	0	2	3	0					
%GROUP%/TYPE%/UID%/PLC/2		S		0	1		D	1	70	2	2	3	0					

The *DSE Module Instrumentation (Modbus Register)* on rows 2, 3 and 4 of the above example are published in one message as they use the same *Topic*.

The subsequent sections of this manual explain in detail what data needs to be entered into each column for the supported functions.

### 6.2.1 TOPIC

**NOTE:** In accordance with the MQTT specification, the names of the Topics are CASE SENSITIVE and must be unique.

**NOTE:** The names for published Topics can be the same however the names for subscribed topics must be unique.

The MQTT Topic names are fully configurable and are entered into the *Topic* column. For Topics whereby the DSE Gateway subscribes to an MQTT Broker, the Topic Name must be unique. For Topics whereby the DSE Gateway publishes to an MQTT Broker, the Topic Name can be repeated for the same *Function* type. Repeating the Topic Name instructs the DSE Gateway to concatenate data into one published message.

To aid using a standardised configuration across multiple DSE Gateways, *Variable Placeholders* may be used within the MQTT Topic name.

Variable Placeholder	Description
%UID%	DSE Module USB ID
%TYPE%	DSE Module Type (e.g 8610, 7310, 6120 etc)
%SITE%	<i>Site Name</i> configured within the DSE Gateway Info section
%GWUID%	DSEGateway USB ID
%GROUP%	<i>Group Name</i> configured within the DSE Gateway MQTT section
%F1% - %F9%	<i>Field 1 to Field 9</i> configured within the <i>Topic File</i> loaded into the DSEGateway (e.g. Modbus/%F1%/F2% could be used to automatically create the topics for Modbus registers defined in Fields 1 and Fields 2 for Function 1)

#### Example of Variable Placeholder

In this example the same *Topic File* is applied to two different DSE8610 modules with USBID's 1234 and 5678, and the DSE Gateway's *Group Name* is configured to DSE. The *Topic File* contains a single published and subscribed Topic.

Topic	Function	Direction
%GROUP%/TYPE%/UID%/Generator_L1-N Translates to: DSE/8610/1234/Generator_L1-N DSE/8610/5678/Generator_L1-N	Gencomm Generator L1-N Voltage Modbus register	Publish to MQTT Broker
%GROUP%/TYPE%/UID%/Control Translates to: DSE/8610/1234/Control DSE/8610/5678/Control	Control Key	Subscribe to MQTT Broker

From the above example, another MQTT Client could then subscribe to the MQTT Broker as shown in the following examples, using standard MQTT wild cards.

Subscription	Description
#	All Data published by the DSE Gateway
DSE/8610/+/Mains_L1-N	L1-N Mains Voltage on both Gensets
DSE/8610/1234/Mains_L1-N	L1-N Mains Voltage on Genset with USBID 1234
DSE/8610/#	All data published by 8610 in Group DSE

From the above example, another MQTT Client could then publish to the MQTT Broker as shown in the following examples, note wildcards cannot be used when publishing.

Publish	Value	Description
DSE/8610/1234/Control	35700	Stop mode on genset with USBID 1234
DSE/8610/5678/Control	35702	Manual Mode on Genset with USBID 5678

### 6.2.2 TOPIC MASK

 **NOTE: This column is currently not implemented and reserved for future use. However, it MUST be included within the *Topic File*.**

The *Topic Mask* column is reserved for future use. Ensure the column is implemented within the *Topic File* but leave the data field empty.

### 6.2.3 TYPE

The *Type* column sets if the MQTT Topic is subscribed or publishing to the MQTT Broker.

Data	Description
S	The MQTT Topic is a subscribe type. The DSE Gateway subscribes to the MQTT Broker to receive data.
P	The MQTT Topic is a publish type. The DSE Gateway publishes to the MQTT Broker so that other MQTT Clients can subscribe to it.

### 6.2.4 PROPERTIES

 **NOTE: This column is currently not implemented and reserved for future use. However, it MUST be included within the *Topic File*.**

The *Properties* column is reserved for future use. Ensure the column is implemented within the *Topic File* but leave the data field empty.

### 6.2.5 PERIOD

 **NOTE: This column is not applicable for subscribed *Type Topics* and is ignored.**

The *Period* column sets the desired update period in seconds for *Topics* that are being Published. The DSE Gateway attempts to maintain this update period but it may be restricted due to bandwidth limitations or the size of the *Topic File*.

To allow published messages to be concatenated, it is advisable to use multiples of the same update period.

#### Example

- Setting an update period to publish one *DSE Module Instrumentation* topic of 5 seconds and another at 6 seconds causes messages to be published at the following times in a 30 second period:  
5, 6, 10, 12, 15, 18, 20, 24, 25, 30
- Setting an update period to publish one *DSE Module Instrumentation* topic of 5 seconds and another at 10 seconds causes messages to be published at the following times in a 30 second period:  
5, 10, 15, 20, 25, 30

As the published *DSE Module Instrumentation* topics in the second example are combined, this reduces the number of messages that are sent compared to the first example.

### 6.2.6 QOS

**NOTE:** Some MQTT Brokers do not support certain levels of Quality of Service (QoS) and can cause disconnection if the wrong unsupported levels are used, refer to the MQTT Broker's documentation for further information.

**NOTE:** Some Cloud Hosted MQTT Brokers have restrictions on the number of messages that it can receive. Higher levels of Quality of Service (QoS) results in a high number of messages for the same quantity of data.

The QoS column sets the desired Quality of Service level for the *Topic* being subscribed and/or published. The Quality of Service is an agreement between the sender of an MQTT message and the receiver of an MQTT message that defines the guarantee of delivery for a specific message. There are 3 QoS levels in MQTT that are set within the *Topic File*:

Data	QoS Type	Description
0	At most once	Fire and Forget, receiver only receives and does not send an acknowledgement
1	At least once	Sent until Acknowledged, receiver could receive the data multiple times until sender receives acknowledgment.
2	Exactly once	Hand Shaked delivery, receiver only gets the data once

Having a Quality of Service set greater than 0 for published messages restricts the rate that messages can be published. For example, when using an ethernet connection to the MQTT Broker:

QoS For All Published Message	Expected Max Message Rate Per Second
0	100
Greater than 0	10

Typically, a mix of Quality of Service is used so the expected message rate would be between the 10 and 100. This is done as some Cloud Hosted MQTT Brokers restrict the number of messages that can be received. Therefore, DSE recommends a Quality of Service of:

- 0 for publishing Topics using Function 1 or 6, if the *Period* is less than 60 seconds.
- 0 for publishing Topics using Function 2 if the *Period* is less than 60 seconds.
- 1 or 2 for subscriptions and other Topic functions.

### 6.2.7 EXPIRY

**NOTE:** This column is currently not implemented and reserved for future use. However, it **MUST** be included within the *Topic File*.

The *Expiry* column is reserved for future use. Ensure the column is implemented within the *Topic File* but leave the data field empty.

### 6.2.8 FLAGS

The *Flag* column sets if the specific *Topic* has additional MQTT functions enabled. This field may consist of any combination of the following in any order, e.g. RW, WR, DWR, RWD.

Data	Flag Type	Description
R	Retain Messages	This instructs the MQTT Broker to retain the value sent by the DSE Gateway until the next message is sent.
W	Last Will Message	<div style="border: 1px solid black; padding: 5px; margin-bottom: 5px;">  <b>NOTE: The <i>Last Will Message</i> is only configurable for one <i>Topic</i> within the DSEGateway <i>Topic File</i>.</b> </div> <p>This instructs the MQTT Broker to inform other subscribed MQTT Clients when the DSE Gateway loses its connection.</p>
D	Debug	This instructs the DSE Gateway to display debug information about the <i>Topic</i> within the <i>Status   Network</i> configuration pages when the <i>Log Level (Diagnostics)</i> is set to <i>Comms</i> or higher. For further information, refer to section entitled <i>Status</i> elsewhere within this document.

## 6.2.9 FUNCTION

The *Function* column sets what that specific *Topic* is desired to be used for. The data sent to the MQTT Broker from the DSEGateway is in a JSON format. The JSON payloads defined for the topic functions follow the following rules

- Keys start with a letter after F in the alphabet (lower or uppercase) so they can be differentiated from the USBID which is string value representing a hexadecimal number.
- Data values are reported as decimal numbers to aid the user in implementing their dashboards. The only exception is the USBID as this is always shown as a hexadecimal identifier in DSE products and is encoded as a string value and treated as the 'name' of the device.
- JSON formatted payloads include the USBID of the target / source of the payload. For Payloads sent from the broker in subscribe packets these can be omitted in which case the target for the payload is only determined by the Topic File containing the matching topic.
- If the USBID is omitted it is possible for a Single Subscribe message to affect multiple modules by defining the same topic in multiple topic files for different modules.
- If the USBID is used then the same topic can be used for multiple modules but the module only acts on the payload if the USBID matches the module USBID, this is required where there are limitations on the topic format i.e. Azure IoT hub.

### 6.2.9.1 0: AUTO SUBSCRIBE FUNCTION

This function is used where a limited number of Subscribe Topics are available. The MQTT Broker determines the function of the *Topic* from the data payload sent by the DSEGateway. This is available for the data about the DSEGateway and connected devices.

#### Topic File Definition

Topic File Column	Data
Type	S
Function	0

#### Example of JSON Data Payload

The following example calls the *1: Gencomm (Modbus) Registers Publish and Subscribe* function if the USBID of the subscribing DSEGateway or DSE Module was 12345678.

```
{"12345678":{"P004":{"R036":1,"R037":2,"R038":196612}}}
```

## 6.2.9.2 1: GENCOMM (MODBUS) REGISTERS PUBLISH AND SUBSCRIBE

**NOTE:** The DSE Modbus register table for the DSE module's is available upon request from the DSE Technical Support Department, support@deepseaelectronics.com. For further information about the DSEGateway's Modbus registers, refer to section entitled *DSEGateway Modbus Registers* found elsewhere in this document.

This function is used to define which Modbus registers (instruments) are Published to the *Topic* by the DSEGateway about itself, or the connected DSE Modules. It can be also used to define which Modbus registers are to be Subscribed too, enabling them to be remotely changed.

**Topic File Definition**

Topic File Column	Data
Type	P (publish) or S (subscribe)
Period	5 to 172,800 (5 s to 48 hours)
Function	1
Field 1	Modbus Page 0 to 255
Field 2	Register Offset 0 to 255
Field 3	Number of registers to publish, maximum 125
Field 4	Modbus Register type: <b>0:</b> 16 bit unsigned (default) <b>1:</b> 16 bit signed <b>2:</b> 32 bit unsigned <b>3:</b> 32 bit signed
Field 5	Word type (optional): <b>0:</b> Big endian (default) <b>1:</b> Little endian

To avoid any potential data or message limits imposed by the MQTT Broker, multiple *Gencomm* (Modbus) *Register* functions can be combined into one MQTT Publish message by using the same *Topic* name in multiple rows of the *Topic File*. For example, with the following two entries into the *Topic File*:

Topic	Topic Mask	Type	Period	QoS	Function	Field 1	Field 2	Field 3	Field 4
%GROUP%/TYPE%/UID%/Mains		P	15	0	1	4	36	2	0
%GROUP%/TYPE%/UID%/Mains		P	15	0	1	4	38	2	2

This would result in one MQTT Publish message for the *Topic* named *%GROUP%/TYPE%/UID%/Mains* to be sent, however it would contain information from:

- Modbus Page 4, Register Offset 36 and 37 as 2 values in 16 bit unsigned format
- Modbus Page 4, Register Offset 38 and 39 as 1 value in 32 bit unsigned format

**Example of JSON Data Payload**

The following example shows an MQTT Publish for the DSEGateway or connected device with a unique ID of 12345678, containing the following information:

- Modbus Page 4, Register Offset 36 and 37 as 2 values in 16 bit unsigned format
- Modbus Page 4, Register Offset 38 and 39 as 1 value in 32 bit unsigned format

```
{"12345678": {"P004": {"R036": 1, "R037": 2, "R038": 196612}, ...}}
```

Whereby:

"12345678" = Unique ID of the DSE Gateway or device.

"P004" = Modbus Page 04

"R036" = Register Offset 36

:1 = A value of 1 coming from Register Offset 36.

### 6.2.9.3 2: GENERIC MODBUS R/W REQUEST (CONFIG SUITE)

 **NOTE:** Use of Function 2: *Generic Modbus R/W request (Config Suite)* must be carefully considered as it can easily lead to message / data limits being reached and thus incurring unexpected charges.

 **NOTE:** Function 2: *Generic Modbus R/W request (Config Suite)* must have a *Topic* within the *Topic File* that is subscribed.

This function is used to enable the DSE Configuration Suite software to read and write configuration files to the DSE module. A DSE Module must be configured to Subscribe for requests and Publish responses when using this function. If either is not defined, a default is created as follows:

- DSE/%UID%/Modbus\_Response – for Publish
- DSE/%UID%/Modbus\_Request – for Subscribe

#### Topic File Definition

Topic File Column	Data
Type	P (publish) and S (subscribe)
Period	0 (on demand in response to request)
Function	2

### 6.2.9.4 3: GENSET CONTROL KEY

 **NOTE:** For further details on Gencomm Control Keys, refer to DSE Publication *056-051 Modbus Control* available from the DSE website at [www.deepseaelectronics.com](http://www.deepseaelectronics.com).

This function is used to control the operating mode of the DSE Module using the predefined Gencomm control keys.

#### Topic File Definition

Topic File Column	Data
Type	S (subscribe)
Function	3

#### Example of JSON Data Payload

The following example shows an MQTT message containing a control command being sent to the DSE Gateway or DSE Module.

```
{"12345678": {"K": 35700}}
```

Whereby:

"12345678" = Unique ID of the DSE Gateway or DSE Module. May be omitted for Subscribed Topics.

"K" = Control Key

:35700 = The value of the control key being sent to the DSE Gateway or device.

## 6.2.9.5 4: ALARM

 **NOTE:** For comprehensive lists of the supported *Unnamed Alarm ID*, *Named Alarm ID* and *Severity ID* for the DSE Module, contact DSE Technical Support, [support@deepseaelectronics.com](mailto:support@deepseaelectronics.com).

This function is used to Publish alarms generated on a DSE Module to an MQTT Broker. Only the alarms that have changed state are sent.

**Topic File Definition**

Topic File Column	Data
Type	P (publish)
Period	0 (on change of alarm state)
Function	4

**Example of JSON Data Payload**

The following example shows three example MQTT Publish messages containing different types of alarms from the DSE Module.

```
{ "12345678" : { "U0001" : { "S" : 3, "T" : 1627298773 }, ... }
{ "12345678" : { "N0001" : { "S" : 3, "T" : 1627298773 }, ... }
{ "12345678" : { "FMI01" : { "SPN000123" : { "A" : 1, "T" : 1627298773 }, ... }, ... },
```

Whereby:

"12345678" = Unique ID of the DSE Module connected to the DSE Gateway.

"U001" = Unnamed Alarm ID, a numeric value between 0 to 999 to indicate which alarm is active.

"N0001" = Named Alarm ID, a numeric value between 0 to 999 to indicate which alarm is active.

"FMI01" = The FMI of the DTC the DSE Module has read from the engine's ECU

"SPN000123" = The SPN of the DTC the DSE Module has read from the engine's ECU

"S" = Severity ID, a numeric value between 0 to 15 to severity of the alarm (e.g. Warning).

"A" = Alarm Active = 1, Alarm Inactive = 0

"T" = UTC Timestamp when alarm changed state

## 6.2.9.6 5: EVENT

 **NOTE:** For comprehensive lists of the supported *Event ID*, *Event Sub Type ID* and *Event Value* for the DSE Module, contact DSE Technical Support, [support@deepseaelectronics.com](mailto:support@deepseaelectronics.com).

This function is used to Publish events logged within a DSE Module's event log to an MQTT Broker. Only newly added events are sent.

**Topic File Definition**

Topic File Column	Data
Type	P (publish)
Period	0 (on change of event state)
Function	5

**Example of JSON Data Payload**

The following example shows an example MQTT Publish message containing an event from the DSE Module's event log.

```
{"12345678":{"E0001":{"S0003":{"P":1,"T":1627298773}}},...},...}
```

Whereby:

"12345678" = Unique ID of the DSE Module connected to the DSE Gateway.

"E0001" = Event ID, a numeric value between 0 to 9999 to indicate which event was triggered.

"S0003" = Event Sub Type ID (Optional), a numeric value to indicate additional information about the event.

"P" = Event Value (Optional), a numeric value normally used to represent a value logged in the event log (e.g. fuel level).

"T" = UTC Timestamp when the event triggered

## 6.2.9.7 6: J1939

**NOTE:** Some MQTT Brokers do not support JSON arrays for values. In these cases, for SPNs larger than 32 bits use the ASCII String type in *Field 8* and decode as a numeric value.

This function is used to Publish J1939 data received on the DSE Gateway's CANbus connection to the MQTT Broker.

**Topic File Definition**

Topic File Column	Data
Type	P (publish)
Period	5 to 172,800 (5 s to 48 hours), 0 = On Change (minimum period of 5 s)
Function	6
Field 1	Source Address to filter, 0 to 254 (255 for no filter)
Field 2	J1939 PGN
Field 3	J1939 SPN
Field 4	Priority to filter, 0 to 7 (255 for no filter)
Field 5	Start Byte, 1 to 1785 (1 to 8 for single part messages, 1 to 1785 for multi-part messages)
Field 6	Start Bit within Field 5, 0 to 7
Field 7	Bit Length (defaults to 8 if not configured)
Field 8	Type <b>0:</b> Unsigned number (or array of unsigned octets if Bit length greater than 32) <b>1:</b> Signed number (or array of unsigned octets if Bit length greater than 32) <b>2:</b> ASCII String interpretation (e.g. 0x44, 0x53, 0x45 = "DSE")

**Example of JSON Data Payload**

The following example shows an MQTT Publish message from the DSE Gateway containing J1939 data from the CANbus connection with *Field 7* specifying a bit length less than 32 bits.

```
{"12345678":{"S001":{"PGN65000":{"SPN03064":1234}},...}
```

Whereby:

"12345678" = Unique ID of the DSE Gateway.

"S001" = Source Address of the J1939 CAN message ID, 000 to 255

"PGN65000" = PGN of the J1939 CAN message ID, 00000 to 65535

"SPN03064" = SPN of the J1939 instrument (as specified in *Field 3* of *Topic File*), 00000 to 524,287

:1234 = Data for the associated SPN which changes depending on *Topic File*.

If *Field 7* specifies a bit length greater than 32 bits, and *Field 8* specifies a type, then an array of unsigned values containing a value of 0 to 255 would be published as shown in the following example.

```
{"12345678":{"S001":{"PGN65000":{"SPN03064":[0,1,2,3,4,5,6,7,8,9,10,11,12,13]}}}}
```

If *Field 8* specifies an ASCII string, the size of the string is defined by *Field 7* which specifies the bit length, or the length from the start of the string in the J1939 message to the end of the J1939 message, whichever is smaller. ASCII characters are encoded following normal JSON encoding rules (0x1A is sent as \u001A, 0x0A is sent as \n) as shown in the following example.

```
{"12345678":{"S001":{"PGN65000":{"SPN03064":"Deep Sea Electronics"}}}}
```

## 6.2.9.8 7: X.509 CERTIFICATE UPDATE

 **NOTE:** This function is only applicable to a *Topic File* for the DSE Gateway.

 **NOTE:** Client Certificates typically expire every 6 to 12 months, and CA Certificates typically expire every 2 to 10 years.

This function is used to update the CA or Client Certificate on the DSE Gateway for communication to the MQTT Broker.

**Topic File Definition**

Topic File Column	Data
Type	S (subscribe)
Function	7

**Example of JSON Data Payload**

The following example shows an MQTT Subscribe message sent to the DSE Gateway for base64 certificate data wrapped in JSON packet and correctly escaped.

```
{"12345678":{"X0":"Certificate"}}
```

Whereby:

"12345678" = Unique ID of the DSE Gateway.

"X0" for CA certificate

"X1" for Client certificate

## 6.2.9.9 8: X.509 CERTIFICATE STATUS

 **NOTE:** This function is only applicable to a *Topic File* for the DSE Gateway.

 **NOTE:** Client Certificates typically expire every 6 to 12 months, and CA Certificates typically expire every 2 to 10 years.

This function is used to check the expiry date of the CA or Client Certificate on the DSE Gateway for communication to the MQTT Broker.

**Topic File Definition**

Topic File Column	Data
Type	P (publish)
Period	5 to 172,800 (5 s to 48 hours)
Function	8
Field 1	Certificate Type <b>0:</b> CA Certificate <b>1:</b> Client Certificate

**Example of JSON Data Payload**

The following example shows an MQTT Publish message from the DSE Gateway containing the expiry date of the CA Certificate.

```
{"12345678" : {"X0" : 1555522027}}
```

Whereby:

"12345678" = Unique ID of the DSE Gateway.

"X0" = Expiry date for the CA Certificate as UTC time stamp

or

"X1" = Expiry date for the Client Certificate as UTC time stamp

### 6.2.9.10 9: TOPIC LIST UPDATE

This function is used to update the *Topic List* stored in the DSE Gateway for itself or the DSE Modules connected to it. This *Topic* must be configured as a Subscribe type, if it is not defined a default is created as follows:

- DSE/%UID%/Topic\_File

#### Topic File Definition

Topic File Column	Data
Type	S (subscribe)
Function	9

#### Example of JSON Data Payload

The following example shows an MQTT Subscribed message sent to the DSE Gateway containing a *Topic File* text wrapped in JSON packet correctly escaped.

```
{"12345678":{"V":"Topic File"}}
```

Whereby:

"12345678" = Unique ID of the DSE Gateway.

"V" = *Topic File*

### 6.2.9.11 10: GPS LOCATION

This function is used to Publish the GPS location of the DSE Gateway or DSE module to the to the MQTT Broker. The Number of Satellites and DOP is readable from the DSEGateway's Modbus registers, refer to section entitled *1: Gencomm (Modbus) Registers Publish and Subscribe* elsewhere in this document.

#### Topic File Definition

Topic File Column	Data
Type	P (publish)
Period	5 to 172,800 (5 s to 48 hours), 0 = On Change
Function	10

#### Example of JSON Data Payload

The following example shows an MQTT Publish message from the DSE Gateway containing the GPS location of the DSEGateway or DSE Module.

```
{"12345678":{"LAT": 54.176182,"LON": -0.311576}}
```

Whereby:

"12345678" = Unique ID of the DSE Gateway or DSE Module.

"LAT" = The latitude of the GPS location in decimal degrees.

"LON" = The longitude of the GPS location in decimal degrees

### 6.2.9.12 11: FIXED DATA

This function is used to Publish an ASCII string from the DSEGateway to the MQTT Broker. This can be used to send connection status to the MQTT Broker. This function is also used to Subscribe the DSEGateway to receive an ASCII string from the MQTT Broker. This is used to help with connection diagnostics.

#### Topic File Definition

Topic File Column	Data
Type	P (publish) and S (subscribe)
Period	5 to 172,800 (5 s to 48 hours), 0 = On Start-up
Function	11
Field 1	Data to publish, can contain <i>Variable Placeholders</i>

#### Example MQTT Payload

The *11: Fixed Data* function does not encode its payload using the JSON format. The payload is transmitted as a raw ASCII string.

The following example shows an MQTT Publish message with Field 1 set to *"%GWUID%":Connected* and the *Flag* set to *R (Retain)*. This results in a message being sent to the MQTT Broker constantly saying the DSEGateway is connected.

```
12345678:Connected
```

Whereby:

"12345678" = Unique ID of the DSE Gateway due to the *"%GWUID%" Variable Placeholder*.

The above example could be altered slightly so the message within Field 1 set to *"%GWUID%":Disconnected* and the *Flag* set to *W (Last Will Message)*. This results in a message being sent to the MQTT Broker when the DSEGateway disconnects.

### 6.2.9.13 12: CONNECTION DETAILS UPDATE

This function is used to update the MQTT connection details configured within the DSEGateway. This *Topic* must be configured as a Subscribe type.

#### Topic File Definition

Topic File Column	Data
Type	S (subscribe)
Function	12

#### Example of JSON Data Payload

The following example shows an MQTT Subscribed message sent to the DSEGateway from the MQTT Broker.

```
{"serverurl":"url_and_port","client":"client_name","user":"user_name","password":"user_password"}
```

Whereby:

"serverurl" = The new *Broker URL* and *Port* to be used by the DSEGateway for connection to the MQTT Broker, entered as URL:PORT (e.g. 192.168.25.56:1883)

"client" = The new *Client Name* to be used by the DSEGateway for connection to the MQTT Broker.

"user" = The new *Username* to be used by the DSEGateway for connection to the MQTT Broker.

"password" = The new *Password* to be used by the DSEGateway for connection to the MQTT Broker.

### 6.2.9.14 13: J1939 DTC

This function is used to Publish J1939 DTC's that have changed state and have been detected on the DSEGateway's CAN port. Only conversion method 4 is supported as per the current J1939 specification.

#### Topic File Definition

Topic File Column	Data
Type	P (publish)
Period	0 = On Change of DTC state
Function	13
Field 1	Source address of the J1939 device.

#### Example of JSON Data Payload

```
{"12345678":{"S001":{"L":0,"FMI01":{"SPN000123":{"A":1,"T":1627298773,"C":3}}}}}
```

Whereby:

"12345678" = Unique ID of the DSE Gateway.

"S001" = Source Address of the J1939 CAN message ID read by the DSE Gateway, 000 to 255

"L" = The J1939 fault lamp status at the time of the DTC activated. The lamp status value is taken from the first 2 Bytes of the DM1 message.

"FMI01" = The FMI of the DTC from the J1939 CAN read by DSE Gateway.

"SPN000123" = The SPN of the DTC from the J1939 CAN read by DSE Gateway.

"A" = Alarm Active = 1, Alarm Inactive = 0

"T" = UTC Timestamp when alarm changed state

"C" = The occurrence count of the DTC from the J1939 CAN read by DSE Gateway.

### **6.2.10 FIELD 1 TO FIELD 9**

The *Field 1* to *Field 9* columns are used to define the parameters required by the *Function* column. For further details on the definitions for these columns, refer to section entitled *Function* found elsewhere in this document.

### 6.3 DSEGATEWAY MODBUS REGISTERS

**NOTE:** The DSE Modbus register table for the DSE module's is available upon request from the DSE Technical Support Department, [support@deepseaelectronics.com](mailto:support@deepseaelectronics.com).

The below table contains all the Modbus register information for the DSEGateway. This information is required when configuring the DSEGateway *Topic Files* and anyone interpreting the data published to the MQTT Broker about the DSEGateway.

Modbus Page	Register Offset	Description	Data Type	Unit	Read/Write
19	40	GPS Valid	Unsigned 16 bit	0 or 1	Read
19	41 to 42	GPS Longitude	Signed 32 bit	Degrees * 1000000	Read
19	43 to 44	GPS Latitude	Signed 32 bit	Degrees * 1000000	Read
19	45	GPS Number of Satellites	Unsigned 16 bit	0 to 99	Read
19	46	HDOP	Unsigned 16 bit	HDOP * 10	Read
19	47 to 48	Module Unix Time	Unsigned 32 bit	Seconds	Read
19	49 to 50	Last GPS Unix Time	Unsigned 32 bit	Seconds	Read
19	51	Speed (Knots)	Unsigned 16 bit	Knots * 10	Read
19	52	Heading	Unsigned 16 bit	Decimal degrees * 10	Read
110	0	Major Software Revision	Unsigned 16 bit	0 to 99	Read
110	1	Minor Software Revision	Unsigned 16 bit	0 to 99	Read
110	2	Build Software Revision	Unsigned 16 bit	0 to 99	Read
110	3	GSM Major Version	Unsigned 16 bit	0 to 999	Read
110	4	GSM Minor Version	Unsigned 16 bit	0 to 999	Read
110	5 to 8	GSM IMEI Number	Unsigned 64 bit	0 to 0xFFFFFFFFFFFFFFFF	Read
110	9	LED State	Unsigned 16 bit 2 bits per LED, GREEN : RED Link LED = Bit 1 to 2 USB LED = Bit 3 to 4 RS485 LED = Bit 5 to 6 CAN LED = Bit 7 to 8	0 to 255	Read
110	10	Sender Input State: On < 100 Ω, Off > 200 Ω	Unsigned 16 bit Input A Bit 1, Input B Bit 2	0 to 3	Read
110	11	Digital Output State	Unsigned 16 bit Output A Bit 1, Output B Bit 2	0 to 3	Read/Write
110	12	Reset Button State	Unsigned 16 bit	0 to 1	Read
110	13	Model Number	Unsigned 16 bit	8904 (890-04)	Read
110	14	Hardware Variant	Unsigned 16 bit	0	Read
110	15	Model Variant	Unsigned 16 bit	0	Read
110	16 to 17	Sender Resistance Value Input A	Unsigned 32 bit	0 Ω to 3000 Ω	Read
110	18 to 19	Sender Resistance Value Input B	Unsigned 32 bit	0 Ω to 3000 Ω	Read
110	20	Plant Battery Voltage	Unsigned 16 bit	0 to 36000mV	Read
110	21	Modem Ready	Unsigned 16 bit	0 to 1	Read

## 7 FIRMWARE UPGRADE

### 7.1 UPDATING THE FIRMWARE

**NOTE:** It is recommended that the DSEGateway®'s configuration is backed up before updating the firmware.

During the lifecycle of the product the firmware may need to be upgraded. Updated Firmware files are released periodically from the Deep Sea Electronics Ltd website and hosted within the DSEGateway® webpage.

A USB memory stick formatted to *FAT* is also required. For further details, see section entitled *How to Format a USB Flash Memory Stick to FAT*, elsewhere in this document.

The *Firmware* version is found in the *Information* page located within the Status page of the DSEGateway®.

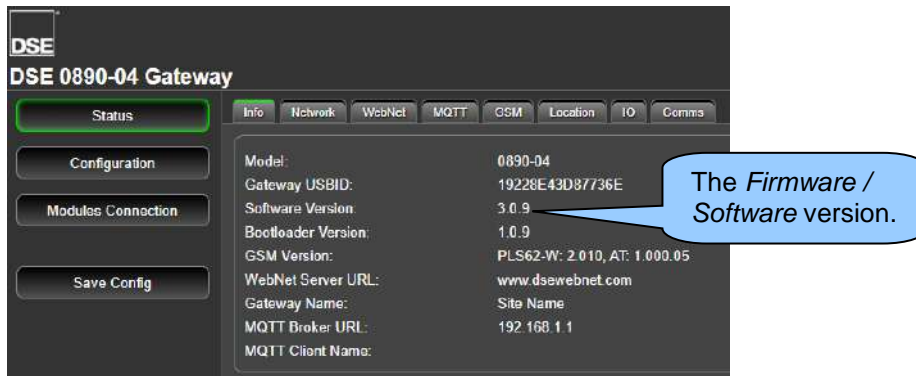

To back up the configuration:

1. Insert the USB memory stick into the DSEGateway®.
2. Navigate to *Configuration | Filesystem* within the DSEGateway® configuration pages.
3. For the parameter *Copy Config To:*, select *USB* followed by clicking on *Copy*. The DSEGateway® configuration is downloaded to the USB memory stick.

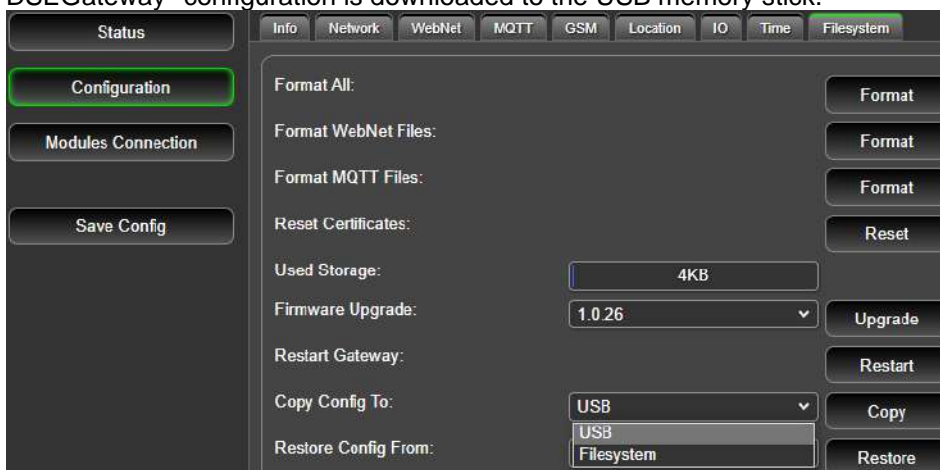

## Firmware Upgrade

To update the Firmware:

- Place the following Firmware update files (where available) onto the USB memory stick.

Description	DSEGateway
Firmware update files	A0890-04.pkg for 0890-001-04 part number. C0890-04.pkg for 0890-002-04 part number.

- Insert the USB memory stick into the DSEGateway®.
- Reboot the DSEGateway®.
- Wait for the four status LEDs to stop cycling, then briefly remain green. The link LED status remains red whilst communications to DSEWebNet® / MQTT Broker are established.
- Remove the USB memory stick.
- The DSEGateway® Firmware has been updated.

If the configuration needs restoring:

- Insert the USB memory stick into the DSEGateway®.
- Navigate to *Configuration | Filesystem* within the DSEGateway® configuration pages.
- For the parameter *Restore Config From:*, select *USB* followed by clicking on *Restore*. The DSEGateway® configuration is uploaded from the USB memory stick.

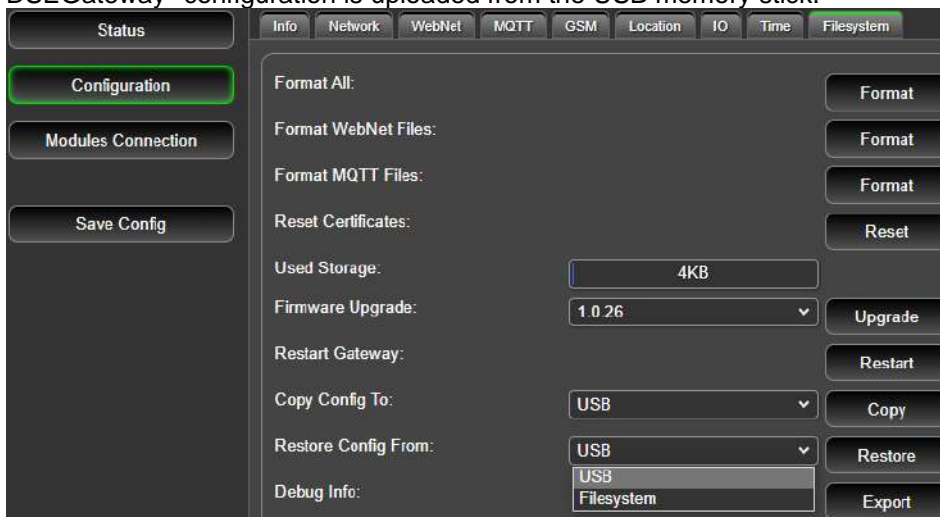

### 7.1.1 HOW TO FORMAT A USB FLASH MEMORY STICK TO FAT

Before updating the DSEGateway® it is necessary to format a USB stick to suit the USB requirements of the Gateway. The instructions below detail how to do this...

- Insert memory stick into PC USB port.
- Browse to *Computer* in Windows Explorer.
- Identify the memory stick, *Right Click* the device, and select *Format*.
- Select *FAT* and click *Start*.

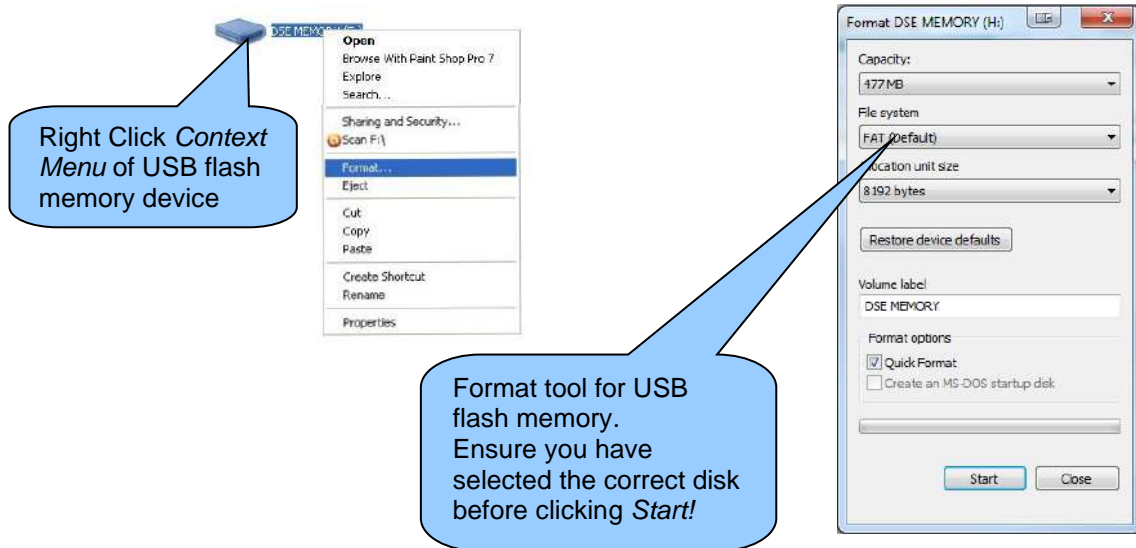

## 8 FAULT DIAGNOSIS

### 8.1 FREQUENTLY ASKED QUESTIONS

Nature of Problem	Suggestion
Factory settings	IP Address: 192.168.1.100 Web Management Pages Port: 80 Username : Admin (case sensitive) Password : Password1234 (case sensitive)
I've forgotten my password and/or IP address	Press and hold the reset push button for five seconds. All LEDs illuminate yellow, then cycle and finally illuminate yellow again. Now release the button. The DSEGateway® is now set back to factory settings.
Management pages cannot be accessed via remote connection	The factory set LAN IP address is 192.168.1.100 Management pages are accessible via web browser on port 80. Check router and firewall settings are configured correctly to match this information. Remember that accessing the DSEGateway® remotely from the WAN (Ethernet) requires IP address of the broadband router to be entered into the PC browser. Port forwarding will also need to be configured. For easier trouble shooting, connect the DSEGateway® directly to a PC Ethernet port.
Management pages cannot be accessed via direct connection to PC	Check network connections. Check network settings. Ensure PC is on the same subnet as the DSEGateway®. Default IP address of the DSEGateway® is 192.168.1.100 – Set the PC to 192.168.1.99 then enter http://192.168.1.100 into the browser.
Communication port LEDs are flashing GREEN	This is normal. The ports flash green when data is successfully received from the connected Module.
Port LEDs illuminate RED for a few seconds at power up of the DSEGateway®.	During the start-up sequence, the port status LEDs illuminate RED. This is normal. When healthy connections are detected and communication is underway, the corresponding LEDs illuminate GREEN.
Multiple LEDs remain RED	This means that at least one of the configured communications ports is not receiving data from the connected Module. Check all configured connections as for LED1, LED2, LED3 and LED4 detailed below.
LED1: LINK LED remains RED	Check connection to broadband modem. Check router and firewall settings. Check IP address, gateway, subnet mask and DNS settings Check the GSM passthrough settings. Check status of connection to host Module. The DSEGateway® does not communicate with the DSEWebNet® server if communications to the Modules is not made.
LED2: USB LED remains RED	This means USB communications is not successful. Check settings of the DSEGateway®. Check USB cable is USB A to USB B type cable. Maximum length of USB cable is 6 m unless third party powered USB extender is used.

Continues overleaf...

*Fault Diagnosis*

<b>Nature of Problem</b>	<b>Suggestion</b>
LED3: RS485 LED remains RED	<p>This means RS485 communications is not successful. Check baud rate and Modbus server ID settings of the DSEGateway® and all connected Modules.</p> <p>Check RS485 cable is the correct type (recommended Belden 9841) with termination resistors correctly fitted at each end of the cable.</p> <p>Max length of RS485 cable is 1.2 km where correct cable and termination resistors are fitted.</p>
LED4: CAN LED remains RED	<p>This means CAN communications is not successful. Check bit rate and source address settings of the DSEGateway® and all connected Modules.</p> <p>Check CAN cable is the correct type (recommended Belden 9841) with termination resistors correctly fitted at each end of the cable.</p> <p>Max length of CAN cable is 40 m where correct cable and termination resistors are fitted.</p>
GPS location is not accurate and/or GPS location moves around.	<p>GPS location accuracy depends upon a lot of factors. Best accuracy (typically around 10 to 20 metres) is achieved when :</p> <ul style="list-style-type: none"> <li>• Using a separate antenna (not combined with GSM)</li> <li>• There is a clear view of the sky not obscured by the control panel roof, tree coverage or heavy clouds.</li> <li>• There are no buildings close by, minimising a wide angle view of the sky.</li> </ul>
Unable to add a DSEGateway® device. "No connection" is reported.	<p>Ensure the monitoring PC has access to <i>realtime.dsewenet.com</i>. Ask the IT department to allow this connection from the company internet connection.</p>

## 8.2 DSEWEBNET CONNECTION TROUBLESHOOTING

**NOTE:** For further assistance when fault finding contact Deep Sea Electronics Technical Support; support@deepseaelectronics.com

If GSM or internet connection issues remain after installing the DSEGateway® navigate to the *Advanced* button located within the DSE *Network* Tab.

Some basic checks are shown below...

### Connection to the DSEWebNet® Servers

Check connection to the DSEWebNet® servers by ensuring Green Ticks against all DSEWebNet® Servers. Each server handles different data streams with the www.dsewebnet.com server gaining connection initially followed by the remaining Realtime and Historic servers.

URL	IP	Status
✓ www.dsewebnet.com	62.128.207.153	OK
✓ gwrealtime.dsewebnet.com:443	62.128.207.133	RECEIVING DATA
✓ historic.dsewebnet.com:443	62.128.207.134	OK

Connection	Description
www.dsewebnet.com	This server allows the DSEGateway® to be added to the DSEGateway® database. Module Description files and remote DSEGateway® configs are transmitted via the DSEWebNet® browser. ✖ = There is no connection to the DSEWebNet® server. The DSEGateway® is not able to register with DSEWebNet®. Suggests that the DSEGateway® is not able to access an internet connection. ✔ = Connection to the DSEWebNet® web browser page is established.
gwrealtime.dsewebnet.com	The Realtime server transmits all live data such as battery voltage and engine speed. ✖ = There is no connection to the Realtime server, ensure port 83 and 443 are not blocked by a firewall. ✔ = Connection to the Realtime server is established.
historic.dsewebnet.com	The Historic server transmits all DSE Module events such as <i>Engine Start / Stop</i> and <i>Mains Failure</i> . These events are then used as an indicator for a Trigger configured on DSEWebNet® ✖ = There is no connection to the Historic server, ensure port 80 and 443 are not blocked by a firewall. ✔ = Connection to the Realtime server is established.

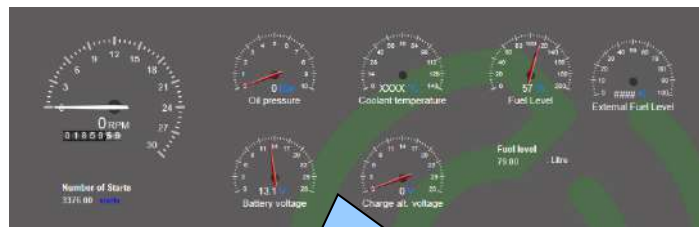

The Historic server transmits all DSE Module events such as *Engine Start / Stop* and *Mains Failure*. These events are then used as an indicator for a Trigger configured on DSEWebNet®

The Realtime server transmits all live data such as battery voltage and engine speed shown on DSEWebNet®

### **Connection to the GSM Network**

Check connection to the GSM Network by navigating to *GSM* page located within the *Status* tab. Check for good signal strength.



Check the DSEGateway® obtains an IP address assigned by the SIM provider...

```
[1] 14:19:39 22/07/2019: GSM : Status: GSM Type 3G CSQ: 0
[1] 14:19:39 22/07/2019: GSM : Status: Registered to home network
[1] 14:19:39 22/07/2019: GSM : Status: IP:172.26.24.187
```

Check the DSE Module Template file has downloaded correctly. The Module Template file allocates memory locations for each specific Module.

```
[1] 11:36:02 26/07/2019: Gencom: Opening file nor:804E0100.xml for parsing
```

Check the DSE Module has a good connection by navigating to the *Modbus* Page located within the *Status* tab. The DSEGateway® should indicate matching data packet values. Failure to do so indicates a poor connection between the DSEGateway® and DSE Module.

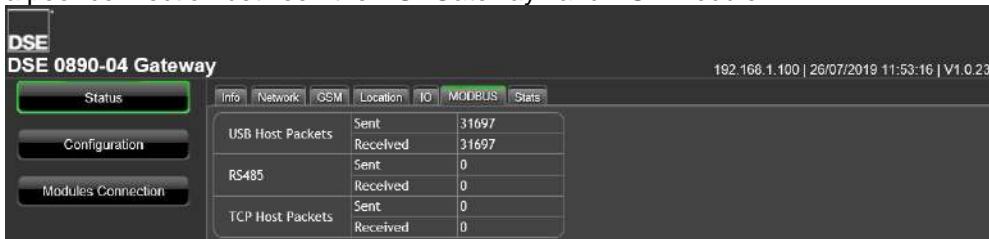

## 9 MAINTENANCE, SPARES, REPAIR, AND SERVICING

The module is designed to be *Fit and Forget*. As such, there are no user serviceable parts. In the case of malfunction, contact your original equipment supplier (OEM).

### 9.1 PURCHASING ADDITIONAL PLUGS FROM DSE

If additional plugs are required, contact the DSE Sales department using the part numbers below.

Module Terminal Designation	Plug Description	Part No.
1 to 7 	7 way 5.08mm	007-447
8 to 13 <b>RS485 CAN</b>	6 way 5.08mm	007-446

### 9.2 PURCHASING AN ADDITIONAL USB CABLE FROM DSE

If a USB cable is required, contact the DSE Sales department using the part numbers below.

Item	Description	Part No.
	USB type A to type B Cable with ferrites chokes, 1 m length. (DSEGateway® to Module).	016-180

### 9.3 PURCHASING AN ADDITIONAL ANTENNA DSE

If an antenna is required, contact the DSE Sales department using the part numbers below.

Item	Description	Part No.
	Combined 4G LTE (Main & Diversity) and GPS Antenna with 3 m length of cable.	020-1053

## 10 WARRANTY

DSE provides limited warranty to the equipment purchaser at the point of sale. For full details of any applicable warranty, contact the original equipment supplier (OEM).

## 11 DISPOSAL

### 11.1 WEEE (WASTE ELECTRICAL AND ELECTRONIC EQUIPMENT)

Electrical and Electronic equipment must be stored, collected, treated, recycled and disposed of separately from other waste.



*This Page is Intentionally Blank*

*This Page is Intentionally Blank*